

REPAIR MANUAL

5 HP - 30



ZF GETRIEBE GMBH SAARBRÜCKEN

Impressum:
Verantwortlich für den Inhalt
Abteilung MKTD, ZF Getriebe GmbH,
Saarbrücken
Druck: HAGER PAPPRINT GmbH,
Gedruckt in der BRD

Published by ZF Getriebe GmbH,
Saarbrücken, Department-MKTD
Printed in Germany by
HAGER PAPPRINT GmbH

CONTENTS

	Page
Preliminary information	1
1. General remarks	2
1.1 Drawing of transmission	2
1.2 Power flow diagram	3
1.3 Oil flow charts	4
1.4 Adjustment work	5/1
1.4.1 Release clearance at clutch F (snap ring)	5/1
1.4.2 Release clearance at brake D (snap ring)	5/2
1.4.3 Release clearance at brake E2 (snap ring)	5/3
1.4.4 Release clearance at brake E1 (snap ring)	5/4
1.4.5 Clearance at output side (washer)	5/5
1.4.6 Release clearance at clutch C (snap ring)	5/6
1.4.7 Release clearance at clutch A (snap ring)	5/7
1.4.8 Release clearance at brake B (snap -ing)	5/8
1.4.9 Transmission end play (shim)	5/9
1.4.10 Adjustment of switches (detent springs)	5/11
1.4.11 Inspection of switches	5/12
1.5 Tightening torques	6
1.6 Troubleshooting (faults, causes and remedies)	7
1.7 Checking the transmission	8
1.8 Special tools	9
2. Dismantling	10
2.1 Dismantling by assembly group	10
2.2 Brake F with 1st gear freewheel	16
2.3 Output	18
2.4 Section I	19
2.4.1 Brakes (D/E2/E1 and 2nd gear freewheel)	19
2.4.2 Planetary gear sets (III, II and I)	24
2.5 Section II	26
(Input with clutches A, B and C)	
2.6 Oil supply	32
2.7 Housing with shift and parking pawl	34
3. Assembly by assembly group	38
3.1 Housing with shift and parking pawl	38
3.2 Brake F with 1st gear freewheel	45
3.3 Section I	51
3.3.1 Planetary gear set (I, II and III)	51
3.3.2 Brakes (E1 and 2nd gear freewheel / E2 and D)	54
3.4 Output side	61
3.5 Section II (input with clutches A, B and C)	64
3.5.1 Clutches A, C (input)	64
3.5.2 Clutch B (input)	69
3.6 Oil supply unit	73
3.7 Selector unit, oil sump and torque converter	77

PRELIMINARY INFORMATION

This manual must only be used in connection with detailed practical training.

This manual contains precise details of how to repair the complete transmission.

All dismantling and assembly work is described in the correct order.

The photographs have been selected to cover various types of transmission and may therefore differ from the vehicle on which you are working.

The component list precisely defines which version of the transmission you are working on, and this is also reflected in the parts list.

If any major modifications have to be taken into account when repairs are carried out, you will be notified by Technical Bulletin.

Depending on the nature of the fault, it may be possible to limit the repair to the actual components and areas of the transmission that have failed.

In this connection, please note:

- Always renew the pistons if there is a fault on brakes „F“, „E1“ or „D“. Always replace (never re-use) seals, for example O-rings and shaft sealing rings as well as filters.
- If the transmission has been run for a considerable distance (>50.000 km), renew all lined and steel discs.
- If clutch damage has occurred the torque converter, oil cooler lines and the oil cooler itself must be thoroughly flushed out with a suitable cleaning agent.

The following requirements must be satisfied:

- The necessary special tools must be available.
The complete set is listed in Section 1.8 of this manual.
- A suitable transmission test rig should be available.
Refer to the Technical Bulletins for the relevant test values.

NOTE:

In this manual the control unit is treated as a single element; it should always be exchanged as a complete unit and not dismantled except by suitably trained personnel possessing full knowledge of its design.

Caution:

The transmission has a „lifetime“ fill of special lubricant.

The transmission has only to be delivered with the correct oil content, as specified in the relevant component list (on microfiche).

Transmissions are supplied by the Service Department partly filled with oil. The dealer is responsible for correcting the oil level.

1. General information

1.1 Drawing of transmission

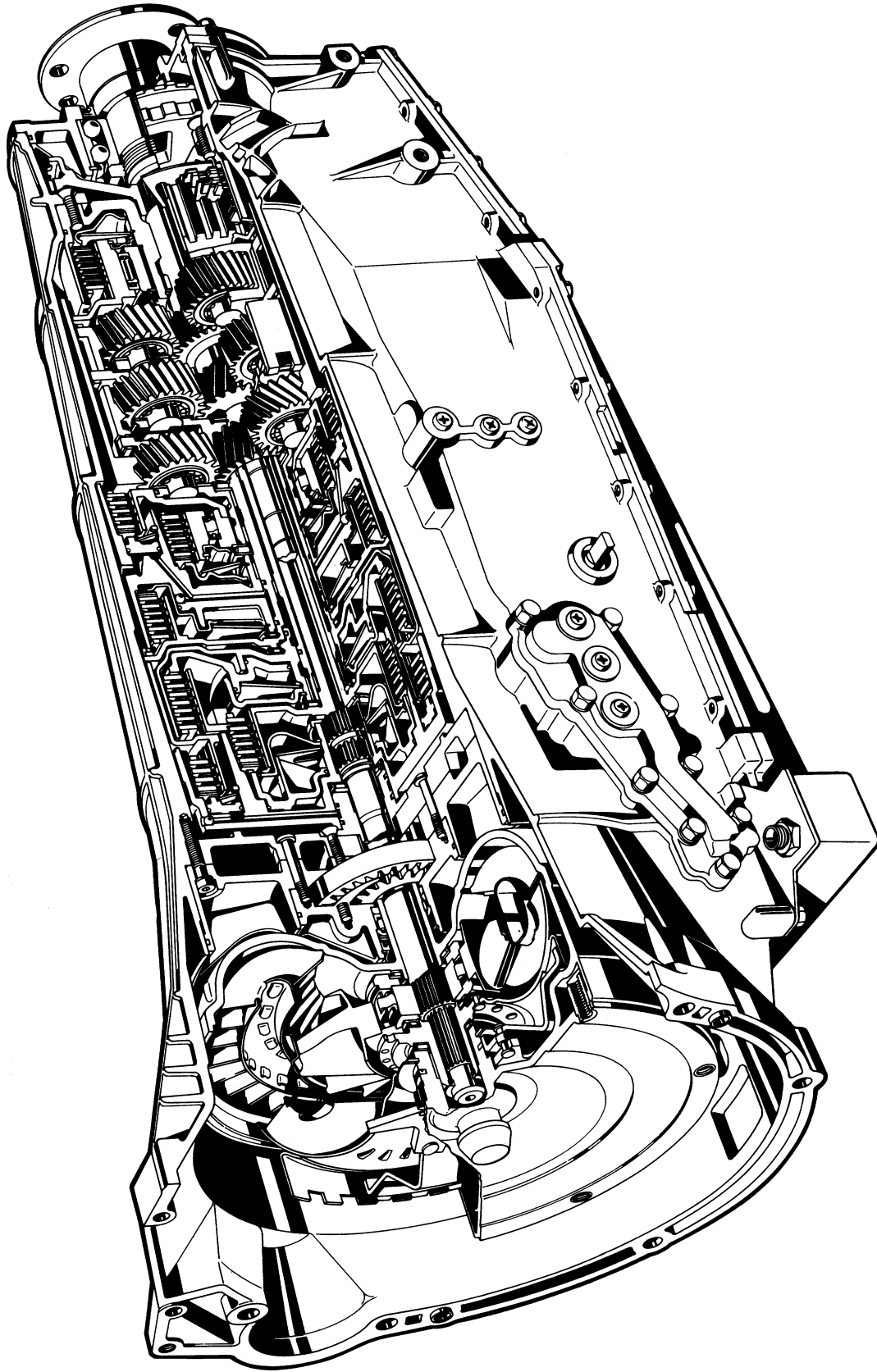

1.2 Power flow

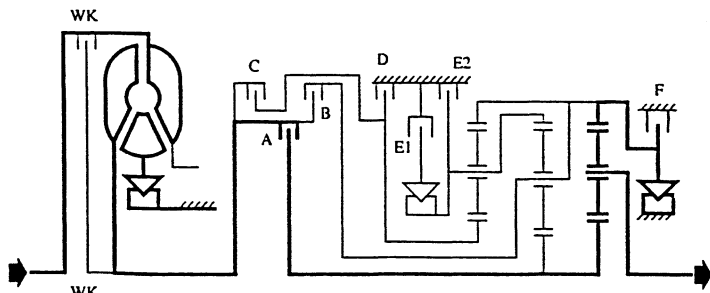

1st gear

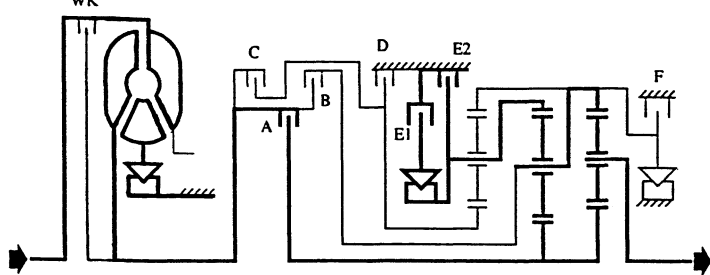

2nd gear

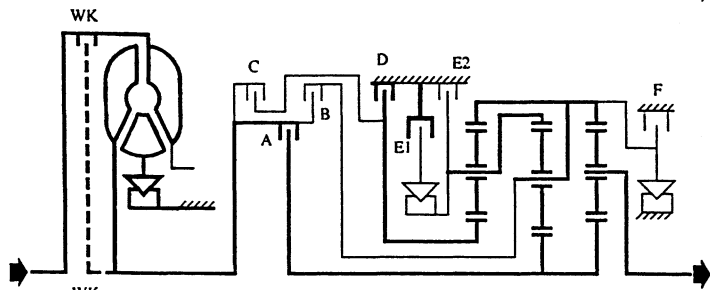

3rd gear

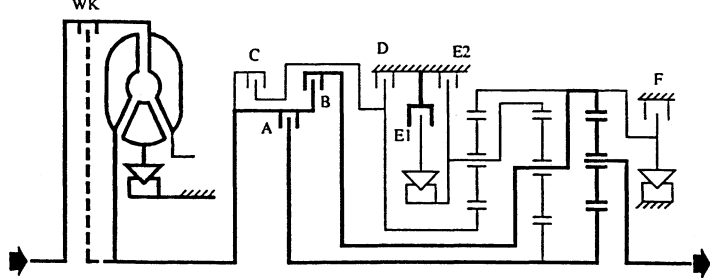

4th gear

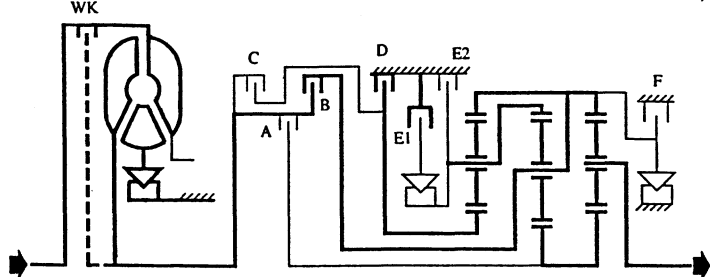

5th gear

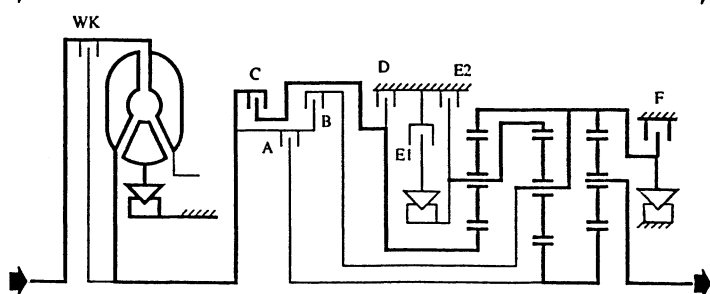

Reverse gear

For a full description, refer to separate documentation.

Position N

Neutral (DIN Symb.)

Neutre

Neutral

Neutra

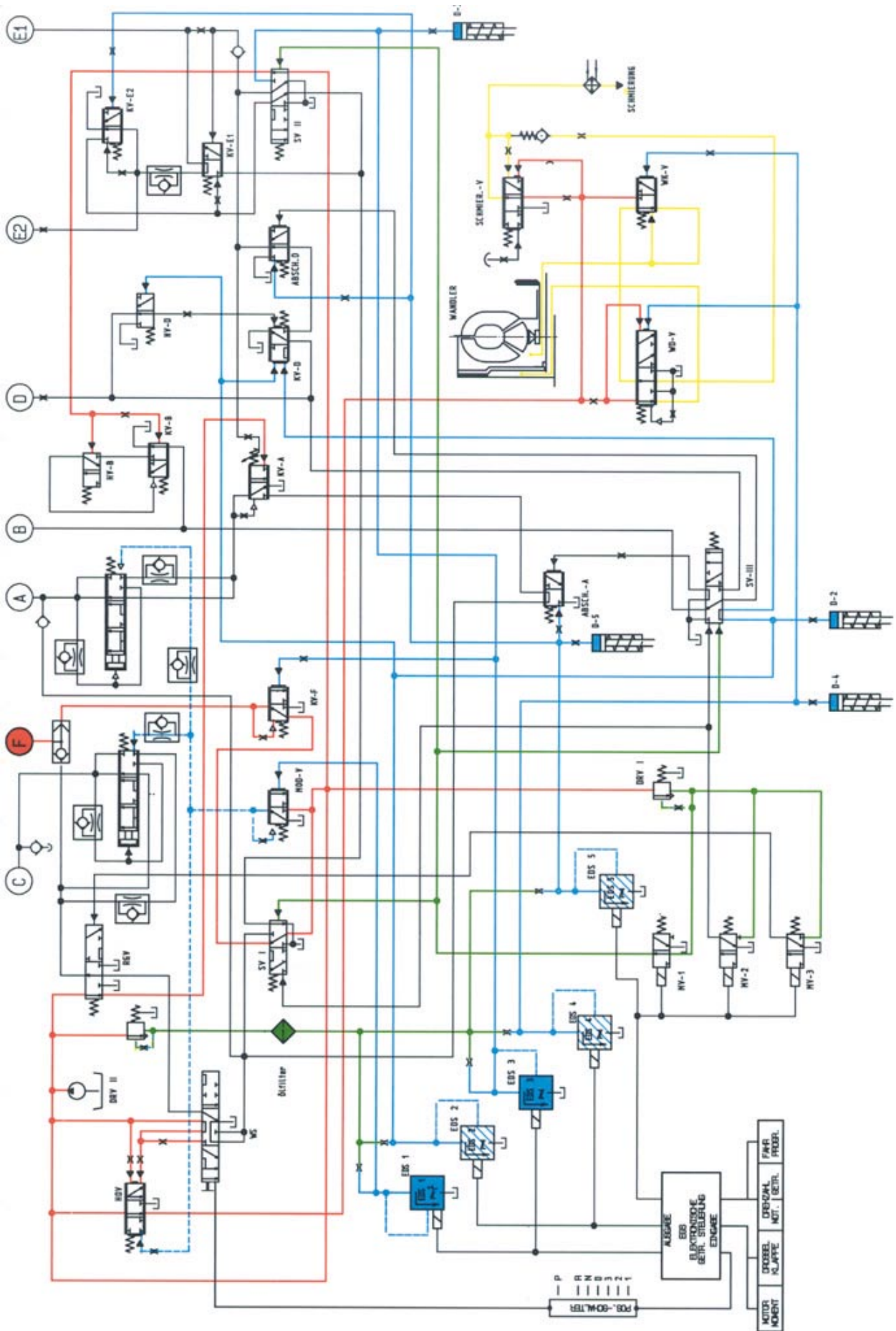

1.4 Adjustment work

1.4.1 Release clearance at clutch F (snap ring)

Insert snap ring 76.210.
(selected thickness = 3.0 mm).
Place dial gauge and bar in position.
Extend dial gauge pointer until it touches the end disc, and set dial gauge to „0“.

92 092

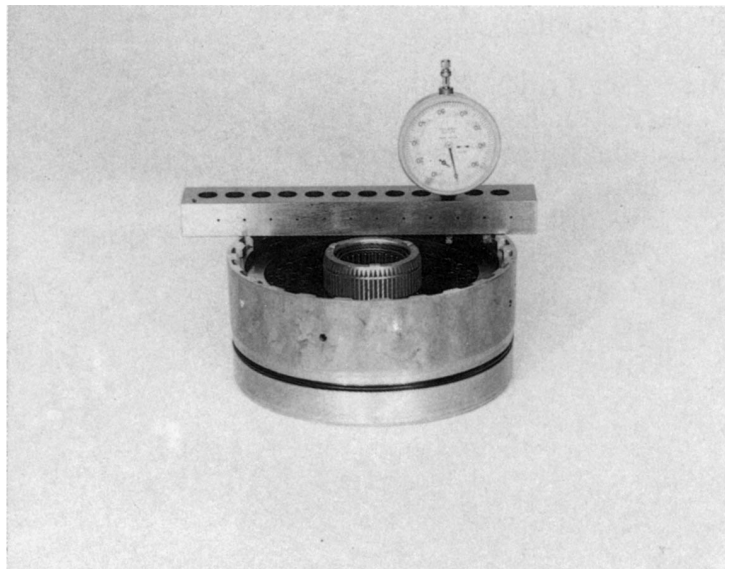

Raise the complete disc set and read off play at the dial gauge.
It should be:
with 6 lined discs = 1.90 - 2.40 mm

92 093

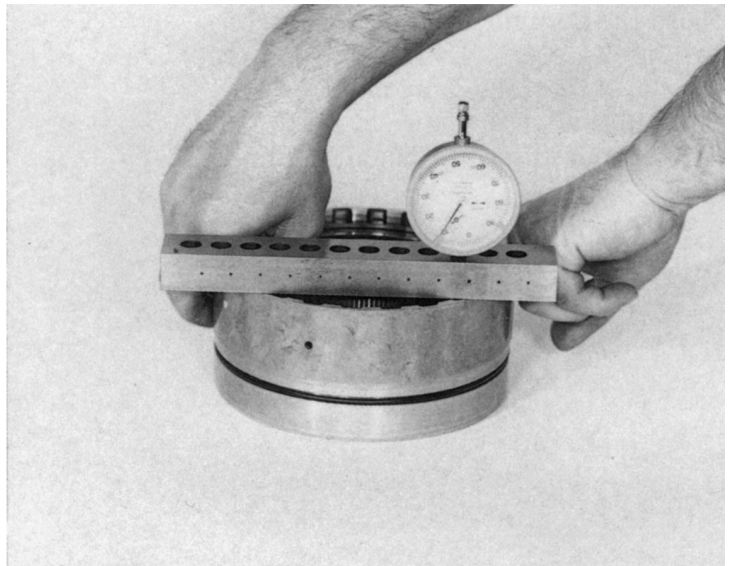

If a different reading is obtained,
select a thicker or thinner snap ring.

92 094

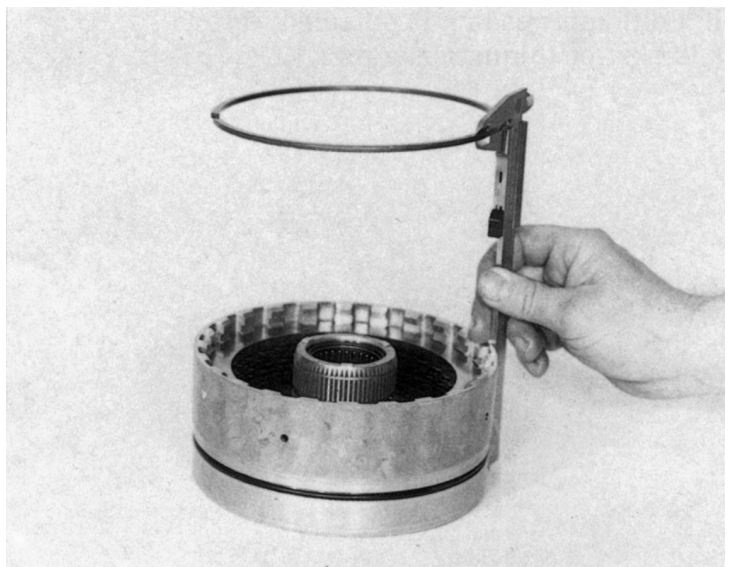

1.4.2 Release clearance at brake G (snap ring)

92 125

Insert snap ring 73.110.
(selected thickness = 3.6 mm)
Place dial gauge with bar in position.
Extend the dial gauge pointer as far as
the final disc and set the dial gauge
to „0“.

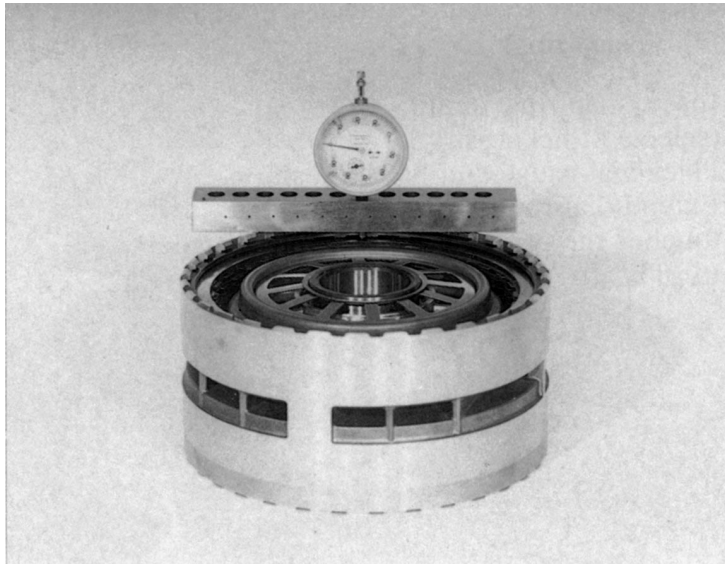

Raise the complete disc set and with
two hooks, e.g. 5 X 46 000 095 and read
off play at the dial gauge.
It should be:
with 5 lined discs = 1.60 - 1.90 mm

92 126

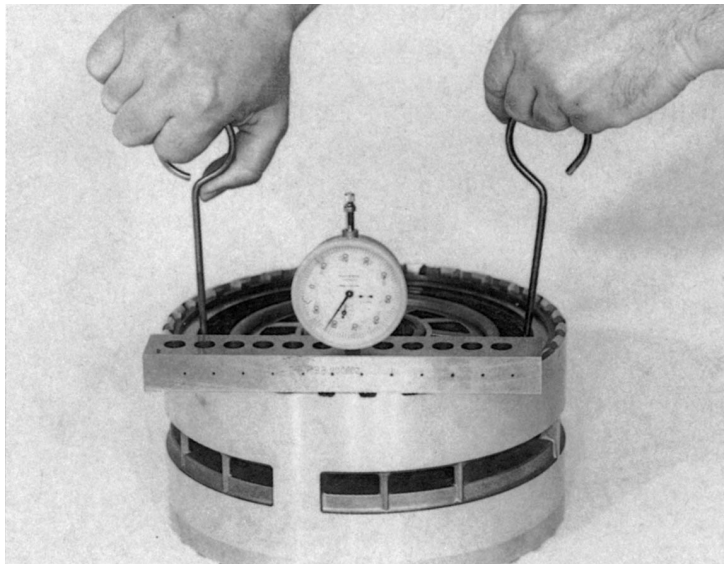

If a different reading is obtained, select
a thicker or thinner snap ring.

92 127

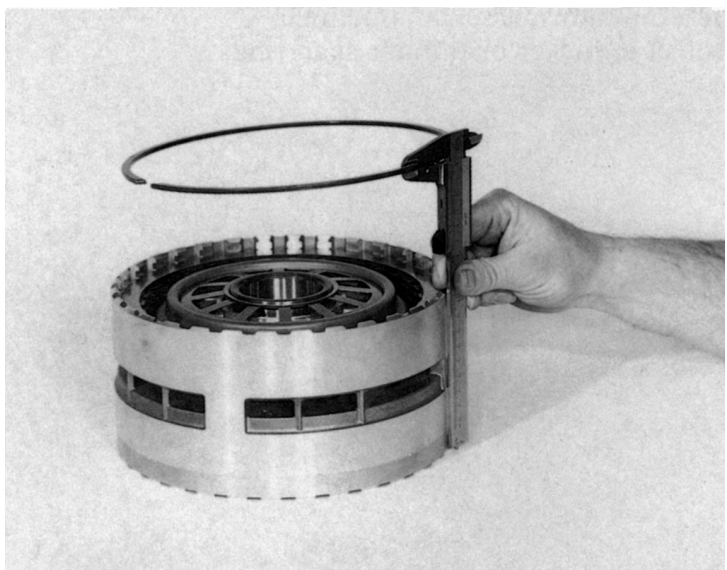

1.4.3 Release clearance at brake E2 (snap ring)

92 129

Insert snap ring 75.120.
(selected thickness = 3.4 mm)
Place dial gauge with bar in position.
Extend the dial gauge pointer as far as
the final disc and set the dial gauge
to „0“.

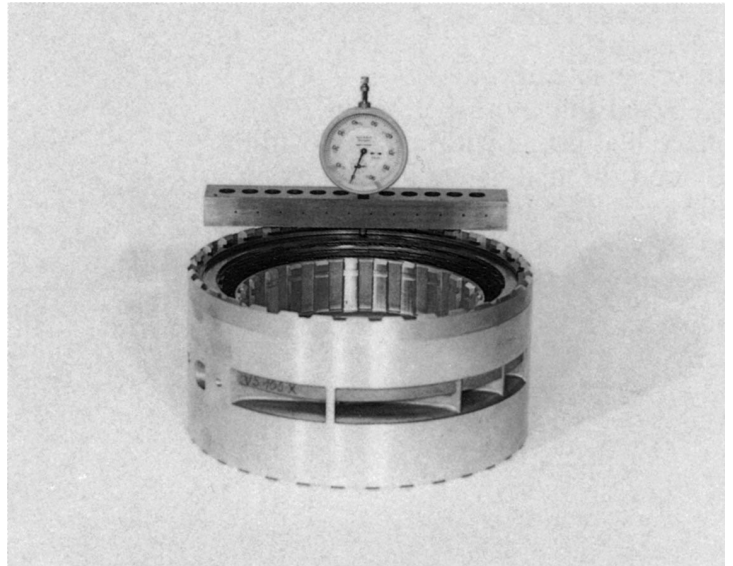

Raise the complete disc set with two
hooks, e.g. 5 X 460 00 095 and read off
play at the dial gauge.
Release clearance should be:
with 4 lined discs = 1.30 - 1.60 mm

92 130

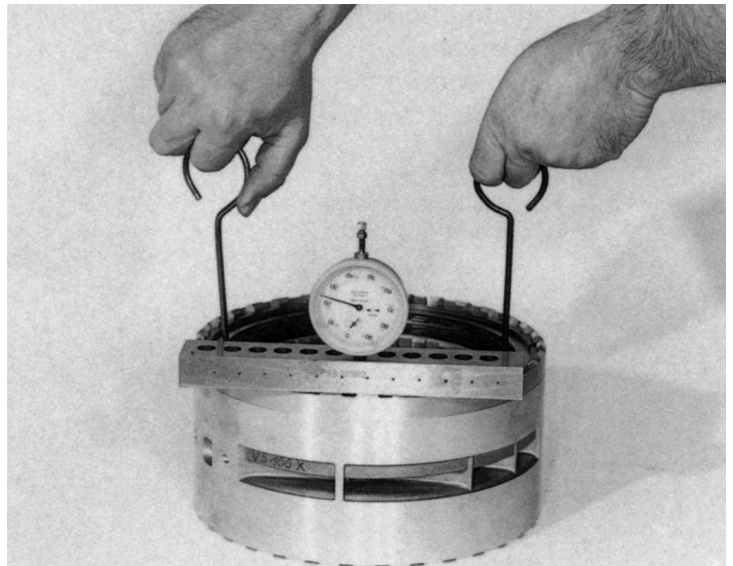

If a different reading is obtained, select
a thicker or thinner snap ring.

92 131

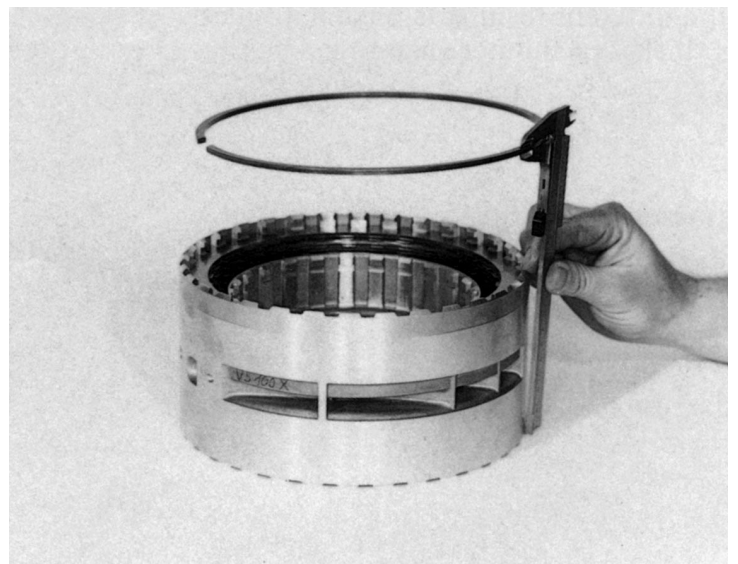

5/3

1.4.4 Release clearance at brake EI (snap ring)

92 133

Insert snap ring 74.090.
(selected thickness = 3.2 mm)
Place dial gauge with bar in position.
Extend the dial gauge pointer as far as
the final disc and set the dial gauge
to „0“.

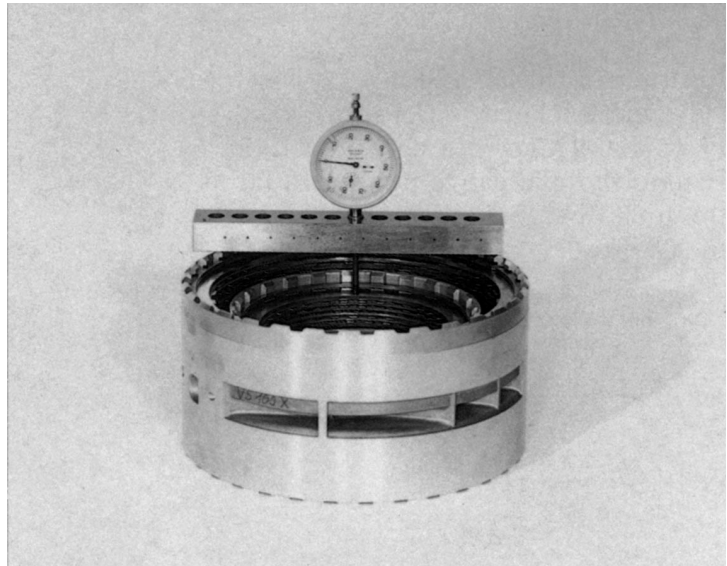

Raise the complete disc set and read
off play at the dial gauge.
Release clearance should be:
with 5 lined discs 1.60 - 1.90 mm

92 134

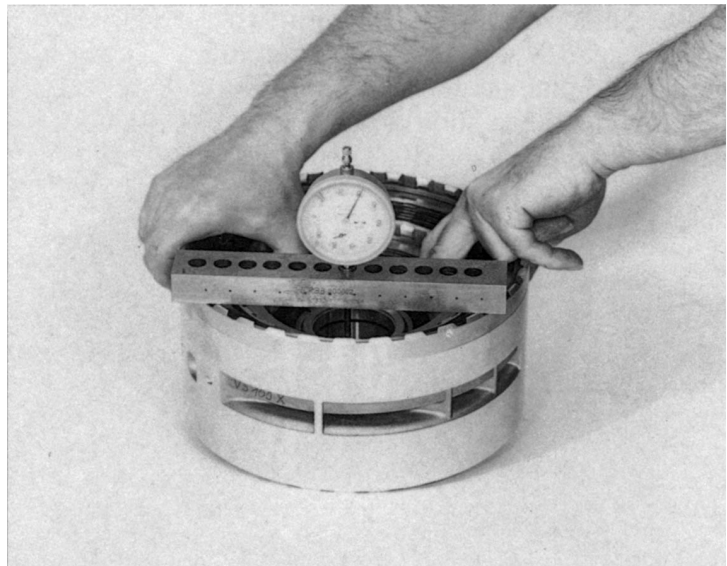

If a different reading is obtained, select
a thicker or thinner snap ring.

92 135

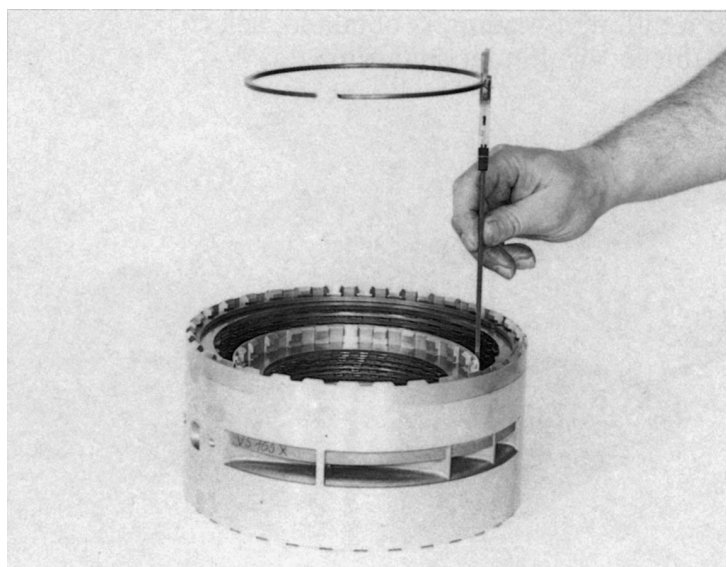

1.4.5 Clearance at output side (shim)

92 145

Dimension A,

Determine distance between machined face of extension and hub of output flange.

Example:

Dimension A = 42.7 mm
(measuring bar thickness of 20.0 mm has been deducted).

Caution!

To avoid inaccurate measurements, do not position on output flange.

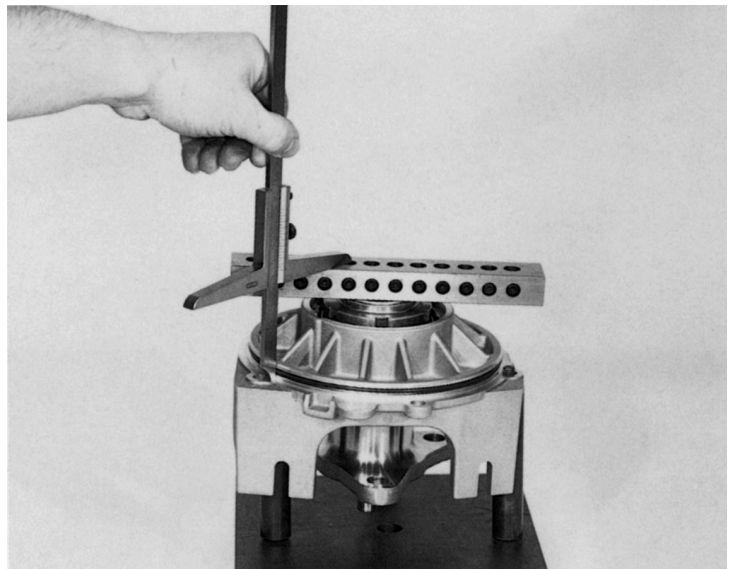

92 146

Dimension B,

Determine distance between machined face of transm. housing and machined face of parking pawl gear.

Example: Dimension B = 44.9 mm
(measuring bar thickness of 20.0 mm has been deducted).

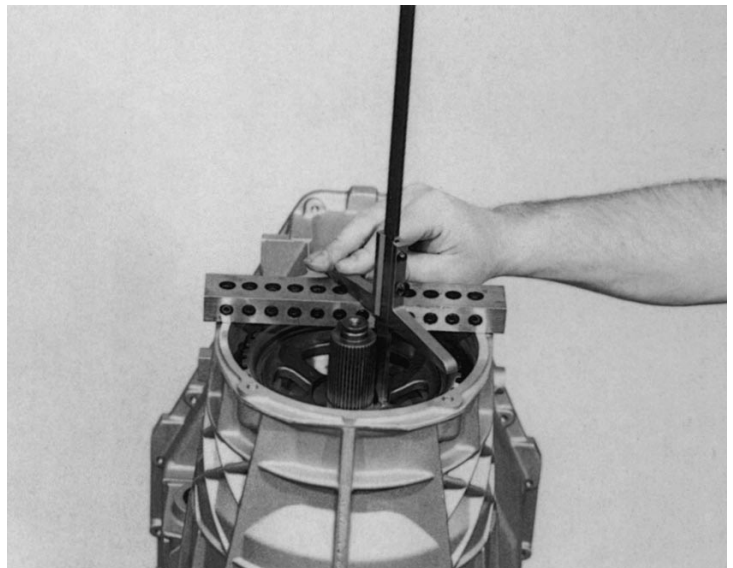

92 147

Determine shim thickness 'S' by applying the following formula:

S = dimension B - dimension A - clearance as per part list.

Example:

S = 44.9 mm - 42.7 mm

= - 0.25 to 0.45 mm

S = 1.95 mm to 1.75 mm

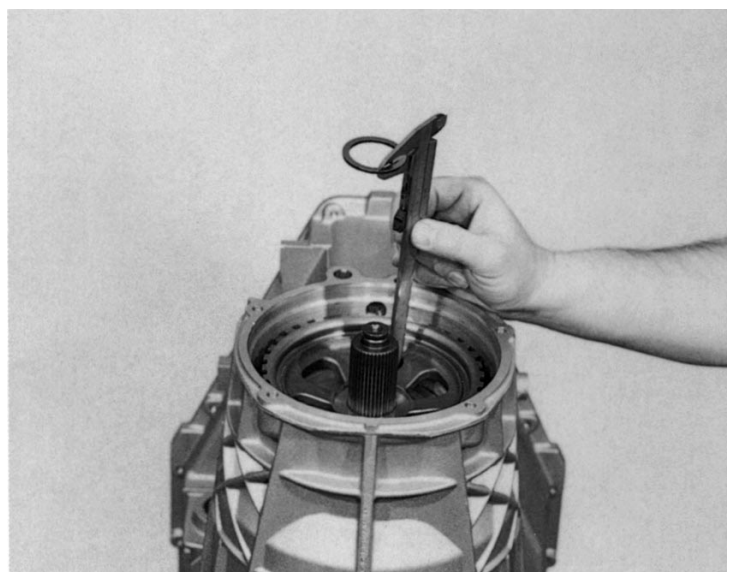

1.4.6 Release clearance at clutch C (snap ring)

92 155

Insert snap ring 70.250.
(selected thickness = 3.1 mm).
Place dial gauge with bar in position.
Extend the dial gauge pointer as far as
the final disc and set the dial gauge
to „0“.

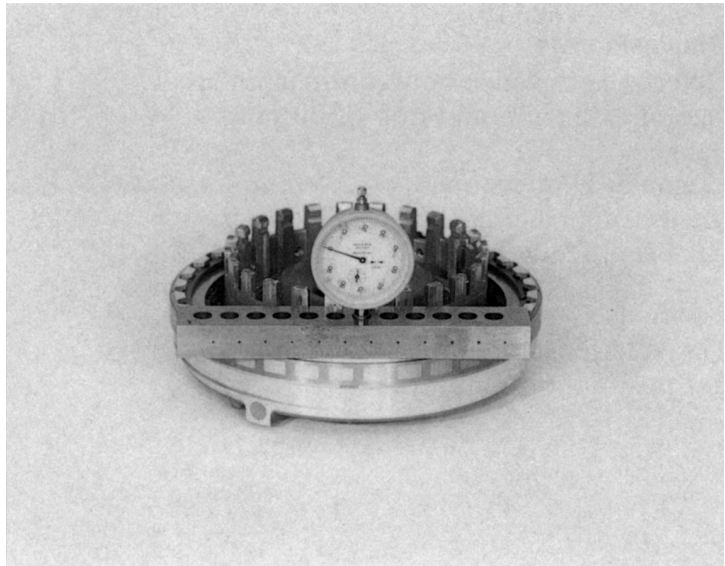

Raise the complete disc set using two
hooks, e.g. 5 X 46 000 095 and read off
play at the dial gauge.
Release clearance should be:
with 3 pairs of discs = 0.80 - 1.20 mm

92 156

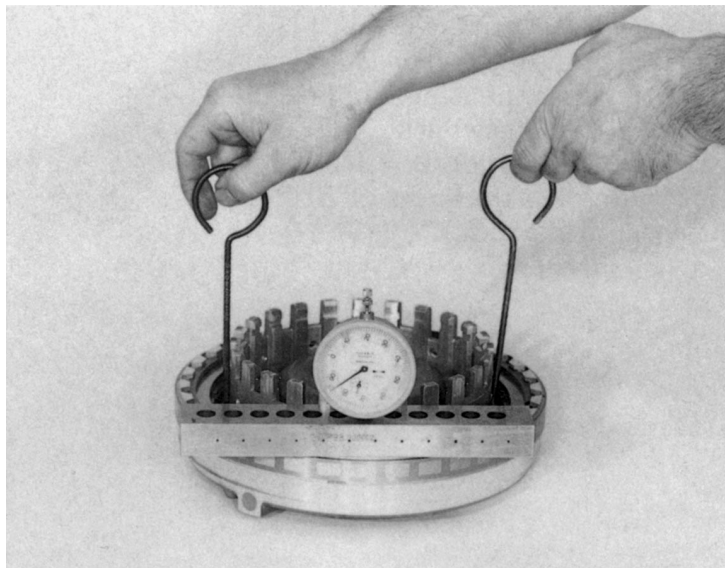

If a different reading is obtained, select
a thicker or thinner snap ring.

92 157

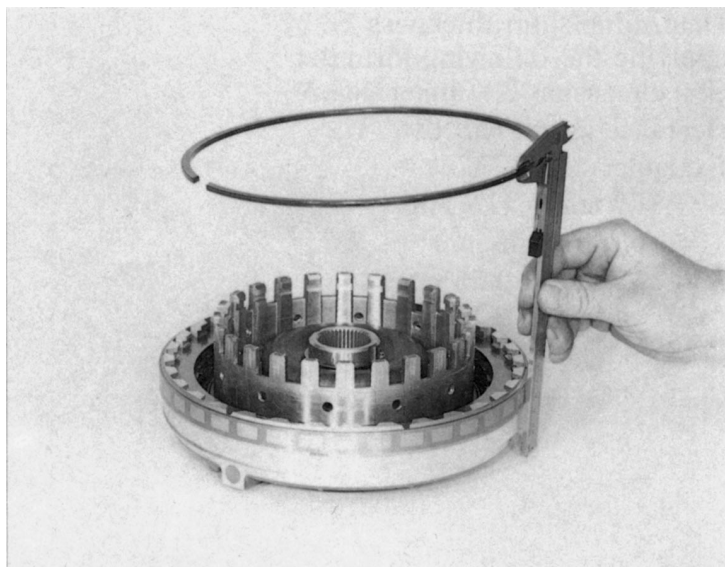

1.4.7 Release clearance at clutch A (snap ring)

92 159

Insert snap ring 70.040
(selected thickness = 2.8 mm).
Place dial gauge with bar in
position. Extend the dial gauge pointer
as far as the final disc and set the dial
gauge to „0“.

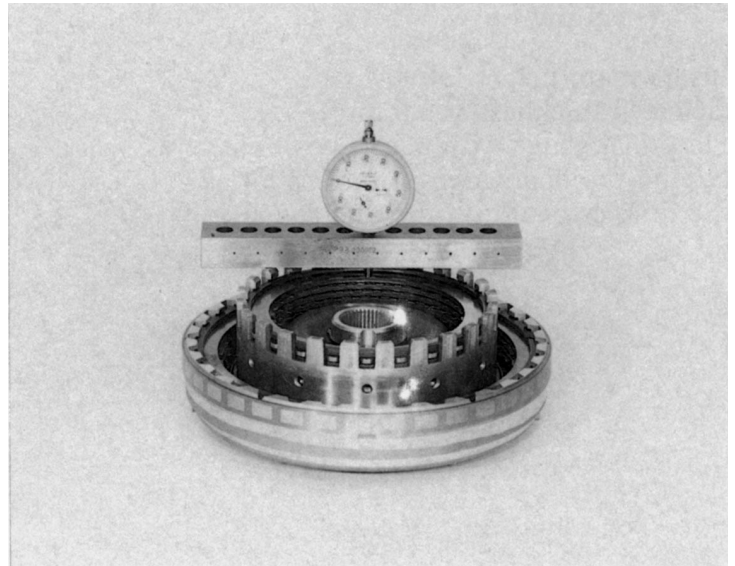

92 160

Raise the complete disc set using two
hooks, e.g. 5 X 46 000 095 and read off
play at the dial gauge.
Release clearance should be:
with 5 pairs of discs = 1.60 - 1.90 mm

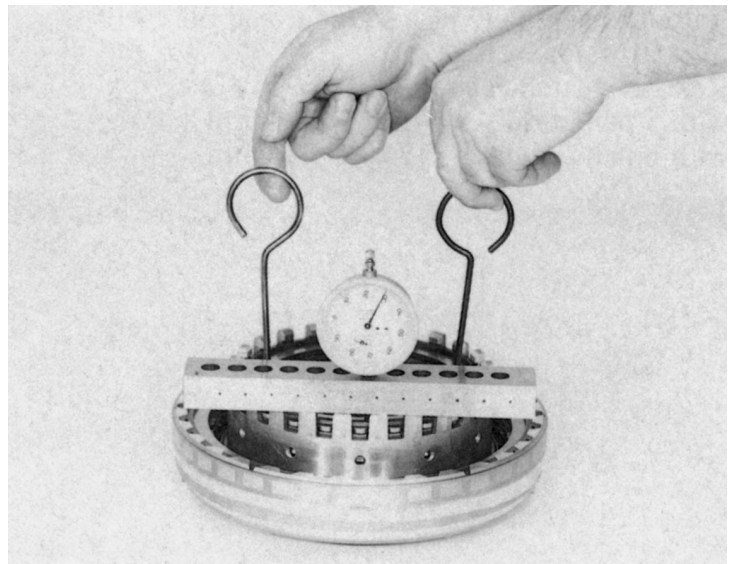

92 161

If a different reading is obtained, select
a thicker or thinner snap ring.

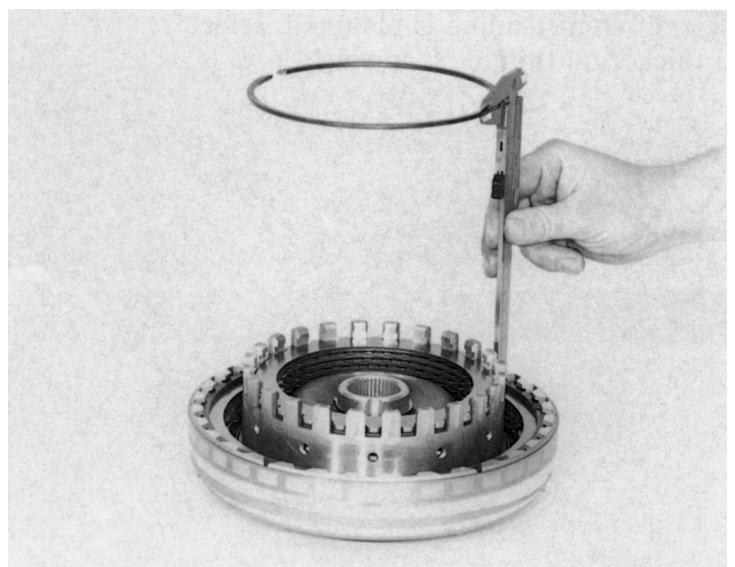

1.4.8 Release clearance at brake B (snap ring)

92 171

Insert snap ring 71.130
(selected thickness = 3.0 mm).
Place dial gauge with bar in position.
Extend the dial gauge pointer as far as
the final disc and set the dial gauge
to „0“.



Raise the complete disc set and read off
play at the dial gauge.
Release clearance should be:
with 5 pairs of discs = 1.60 - 1.90 mm
with 6 pairs of discs = 2.00 - 2.30 mm

92 172

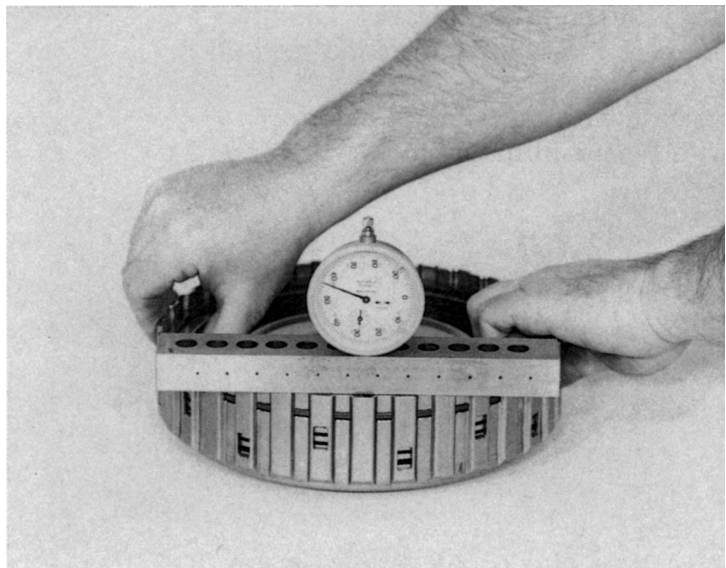

If a different reading is obtained, select
a thicker or thinner snap ring.

92 173

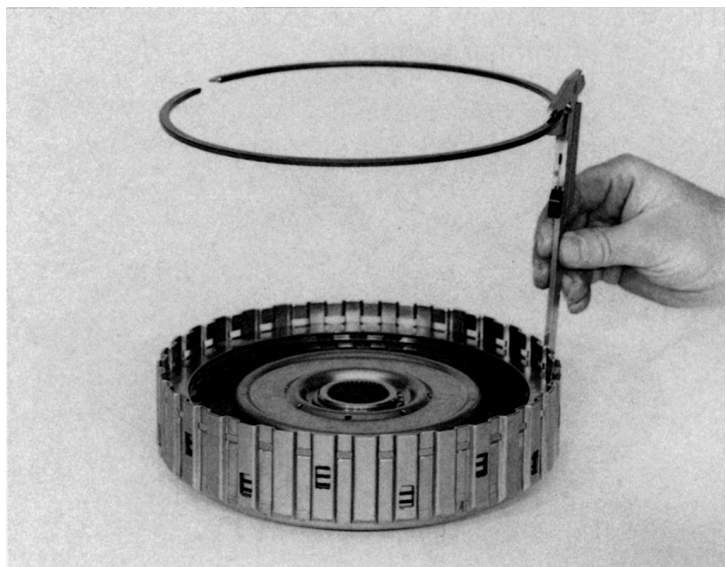

1.4.9 Transmission end play (shim)

92 186

Requirements:

Angle disc 02.210, needle roller thrust bearing 02.220 and shim 02.230 (selected thickness = 2.0 mm) are fitted.

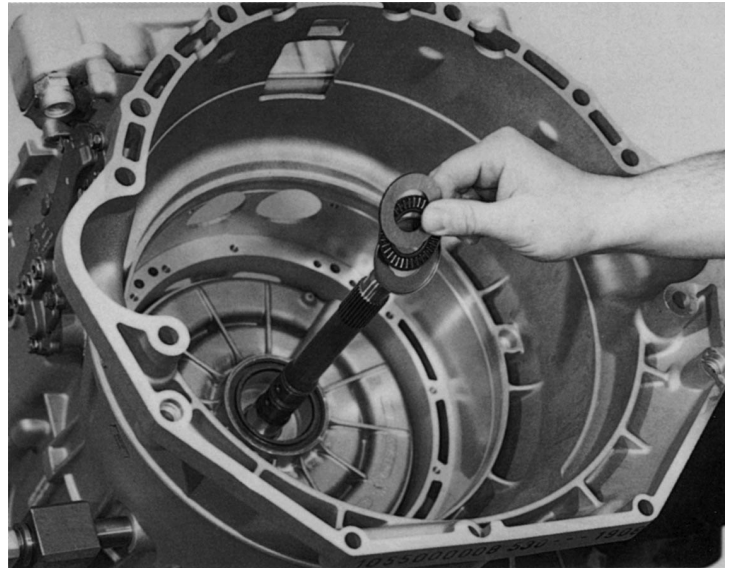

92 187

Clamp assembly fixture 5 X 46 000 563 on to the stator shaft and align the rectangular-section rings. Connect up the oil supply unit, aligning the suction and pressure channels linking oil supply unit and transmission housing.

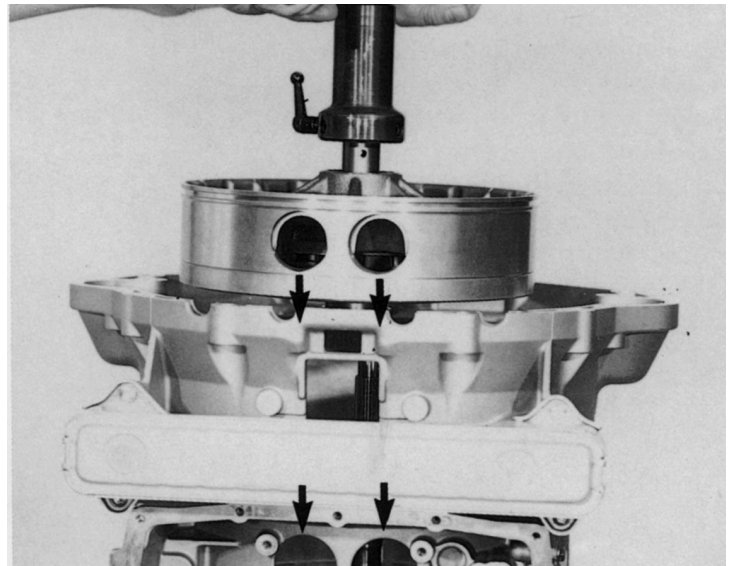

92 188

Attach the oil supply unit with two machine screws on opposite sides. (Wrench size = Torx - TX 27) (tightening torque = 10 Nm)

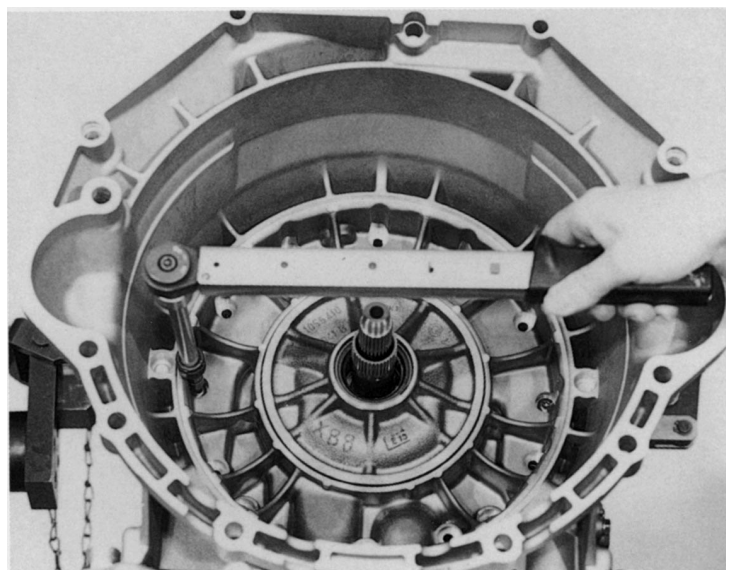

Clamp the sleeve of measuring device 5 P 0 100 1415 by its 3 retaining bolts to the stator shaft, so that no play is present.

Push measuring device 5 P 01 001 415 over the input shaft splines and secure with the locking screw so that it cannot tilt.

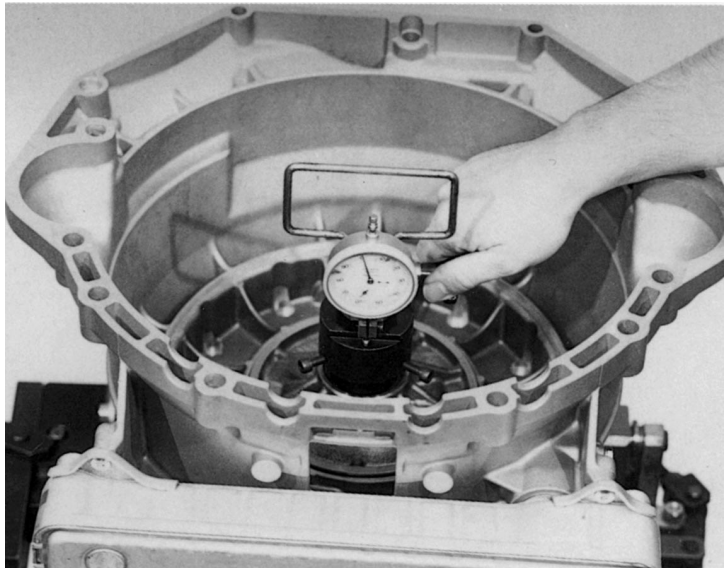

Pull the handle to determine end float (take the measurement more than once).

Desired end float value = 0.10 - 0.30 mm.

If this value is not reached, insert a thicker or thinner washer 02.230, than check end float again. Unscrew and lift out the oil supply unit.

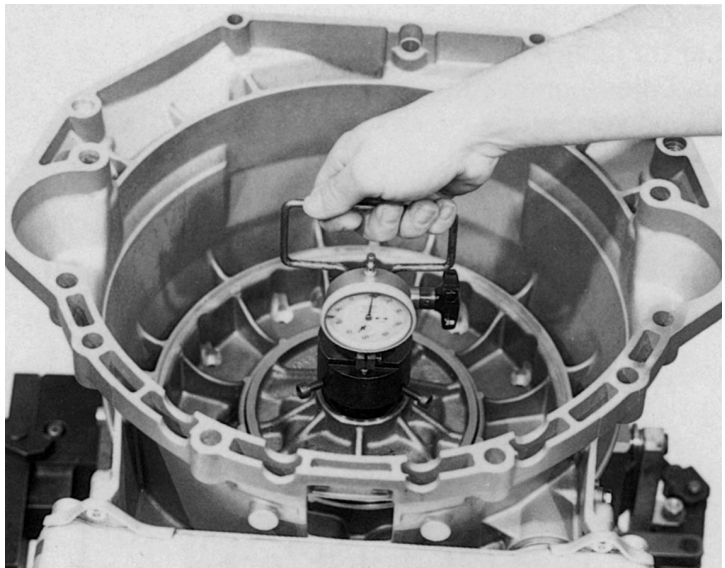

1.4.10 Adjustment of switches (detent springs)

92 233

Position detent disc in setting N (Neutral) using suitable tool or by hand.

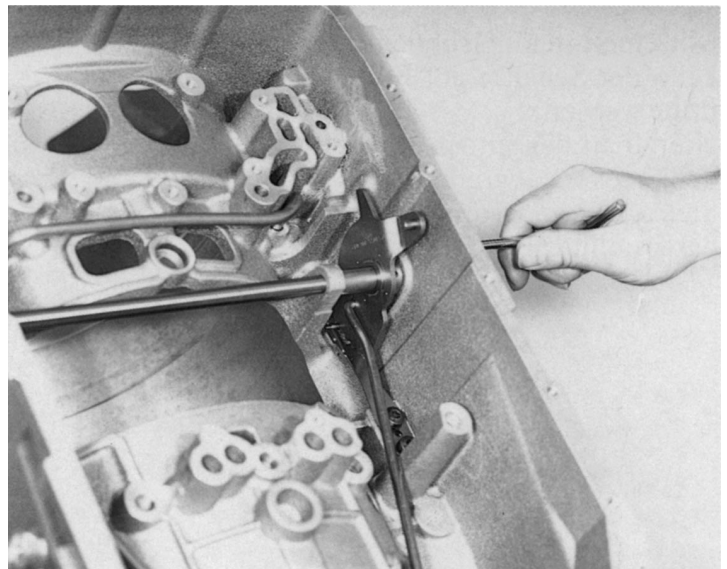

92 234

Attach position gage 5 P 01 002 368 to the selector shaft and eliminate clearance by rotating knurled screw. Rotate position gauge in such a way that the locating bolts (dowels) in the transmission housing mate with the groove in the gauge.



92 235

Secure detent spring in this position.
(Wrench size = Torx - TX 27)
(tightening torque = 10 Nm)

Release position gauge and move selector shaft from N to P and back to setting N.

When fitted correctly, the position gauge locates flush with the selector shaft and the transmission housing.

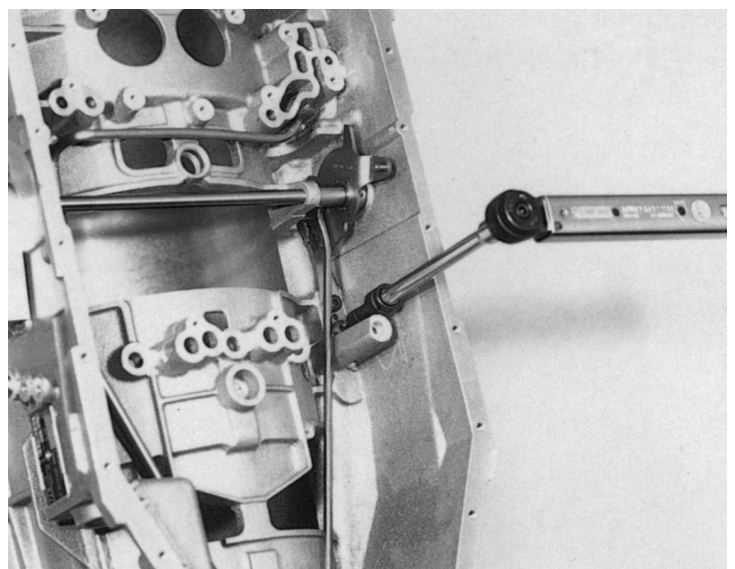

1.4.11 Inspection of switches (detent springs)

Using a standard tester unit, check the function of the switch.

To do this, connect tester to relevant pins on plug. Plug is shown as viewed from the front.

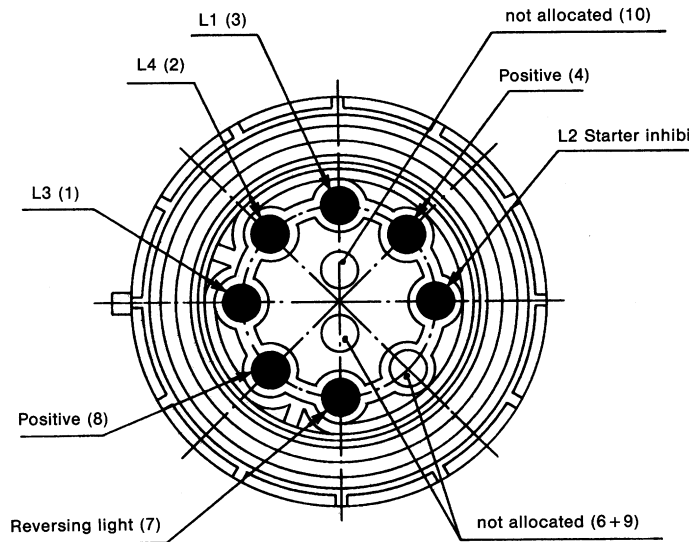

In accordance with the coding table, check the ohm ratings.

Example: measure setting „R“ between

Pos. (4) and L1 (3) —> „0“ Ohms

Plus (4) and L3 (1) —> „∞“ Ohms

Plus (4) and L4 (2) —> „∞“ Ohms

Starter inhibit:

Pos. (4) and L2 (5) —> „∞“ Ohms

Reversing light:

Pos. (8) and (7) —> „0“ Ohms

Coding table 5 HP 30

Setting	Selector position				Starter inhibit		Rev. lig
	Pos. (4)	L1 (3)	L3 (1)	L4 (2)	Pos. (4)	L2 (5)	Pos. (8)
P	*	*		*	*	*	
R	*	*					*
N	*	*	*		*	*	
D	*	*					
4	*			*			
3	*		*	*			
2	*	*	*	*			

Diagram of switch is illustrated in the right hand column:

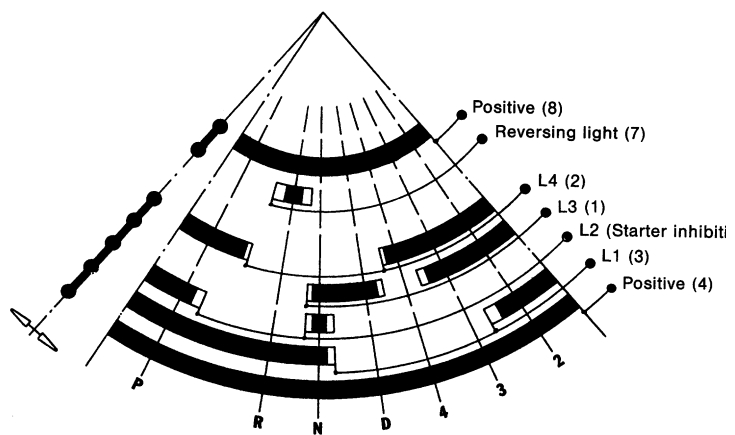

1.5 Tightening torques

Item	Wrench size	See page	Tightening torque
- Machine screw (oil pipe)	TORX - TX 27	39	10 Nm
- Hex screw (cover)	10 mm across flats	39	8 Nm
- Screw plug (transmission housing cover)	Allen screw, 5 mm across flats	40	15 Nm
- Machine screw (oil cooler)	TORX - TX 27	40	8 Nm
- Machine screw (detent spring)	TORX - TX 27	41,5/11	10 Nm
- Machine screw (guide plate)	13 mm across flats	43,79	23 Nm
- Hex screw (switch)	10 mm across flats	43	8 Nm
- Machine screw (cable clip)	TORX - TX 27	44	8 Nm
- Countersunk screw (cylinder F)	TORX - TX 40	50	23 Nm
- Machine screw (complete planetary gear set)	TORX - TX 50	60	See directive
- Slotted nut (output side)	Socket wrench 5 X 46000787	62	120 Nm
- Hex screw (output side)	13 mm across flats	63	23 Nm
- Countersunk screw (stator shaft/ centering plate)	TORX - TX 27	75	10 Nm
- Countersunk screw (interm. plate/ pump)	TORX - TX 27	75	10 Nm
- Countersunk screw (interm. plate/ pump)	TORX - TX 27	75	5 Nm
- Machine screw (oil supply unit)	TORX - TX 27	5/9, 76	10 Nm
- Machine screw (shift unit)	TORX - TX 27	78	8 Nm
- Machine screw (filter)	TORX - TX 27	79	5 Nm
- Machine screw (oil sump)	TORX - TX 27	80	10 Nm
- Screw plug (oil sump) M 24 x 1.5	Allen screw, 14 mm across flats	80	50 Nm
- Screw plug (oil sump) M 30 x 1.5	Allen screw, 17 mm across flats	80	100 Nm

1.7 Checking the transmission

The following points must be checked:

Oil level correct

Comply with the vehicle manufacturer's instructions.

Oil level too low

The engine will overspeed when the vehicle is cornered; there will be valve chatter as a result of air inclusions and general malfunctioning of the transmission.

Oil level too high

Risk of severe splash losses and foaming, severe rise in temperature if driven fast. Oil lost through breather.

Correct engine settings

Correct idle speed (comply with vehicle manufacturer's instructions).

Drive taken up forwards and in reverse

Selector linkage or cables correctly adjusted (comply with vehicle manufacturer's instructions).

Shift quality

See troubleshooting table.

Noise

See troubleshooting table.



Fault memory

If activated, comply with vehicle manufacturer's instructions.

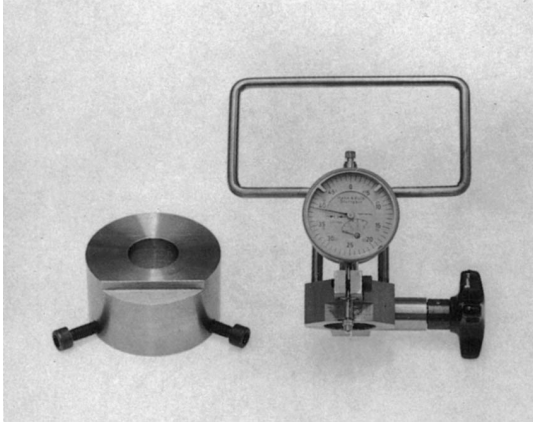
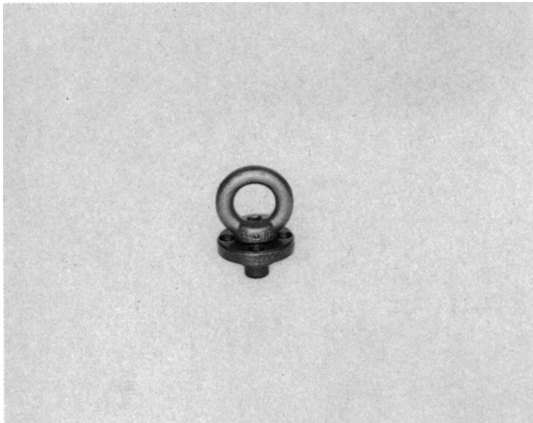
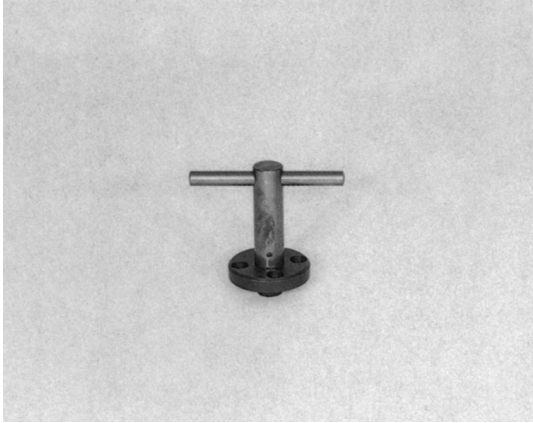
1.8 Special tools 5 HP 30

Illustr. No.		Order No. / Purpose	Remarks
1	<p data-bbox="312 360 400 394">82 183</p> 	<p data-bbox="898 369 1158 427">5 P 01 001 415 - End play measuring device</p>	<p data-bbox="1409 369 1517 456">Identical to 4 HP 22 5 HP 18</p>
2	<p data-bbox="312 925 400 958">92 205</p> 	<p data-bbox="898 934 1190 1021">5 W 46 000 003 - Adapter unit for lifting fixture brake F / unit II</p>	
3	<p data-bbox="312 1491 400 1525">92 206</p> 	<p data-bbox="898 1500 1163 1588">5 X 46 000 004 - Hand grip for lifting fixture - brake F / unit II</p>	<p data-bbox="1409 1498 1525 1619">Alternative to 5 W 46 000 003</p>

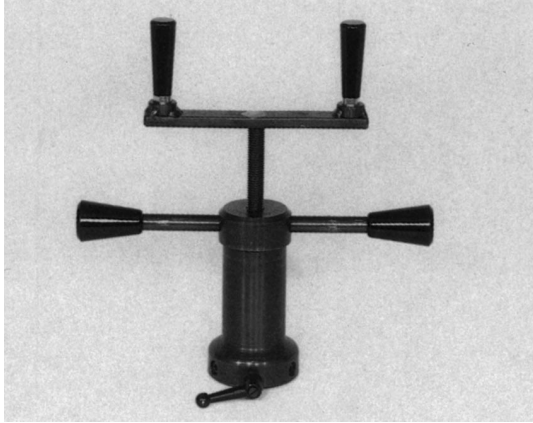
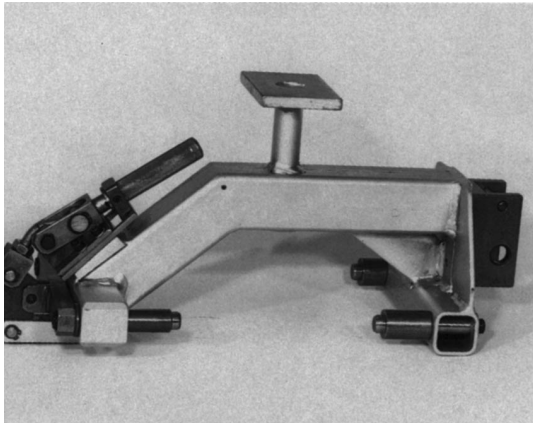
1.8 Special tools 5 HP 30

Illustr. No.		Order No. / Purpose	Remarks
4	<p data-bbox="256 360 344 394">91 190</p> 	<p data-bbox="842 367 975 394">5 X 46 000 563</p> <p data-bbox="842 400 1091 459">- Assembly fixture for oil supply unit (complete)</p>	<p data-bbox="1353 367 1461 425">Identical to 5 HP 18</p>
5	<p data-bbox="256 925 344 958">91 194</p> 	<p data-bbox="842 934 975 960">5 X 46 000 635</p> <p data-bbox="842 967 1145 1025">- Assembly bracket for complete transmission</p>	<p data-bbox="1353 934 1461 992">Identical to 5 HP 18</p>
6	<p data-bbox="256 1489 344 1523">92 207</p> 	<p data-bbox="842 1498 975 1525">5 X 46 000 688</p> <p data-bbox="842 1532 1015 1590">- Assembly sleeve, - selector shaft</p>	

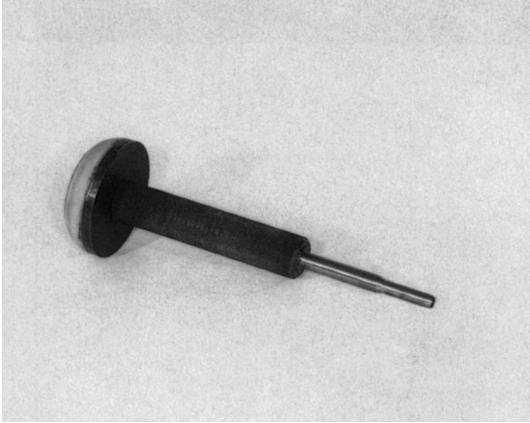
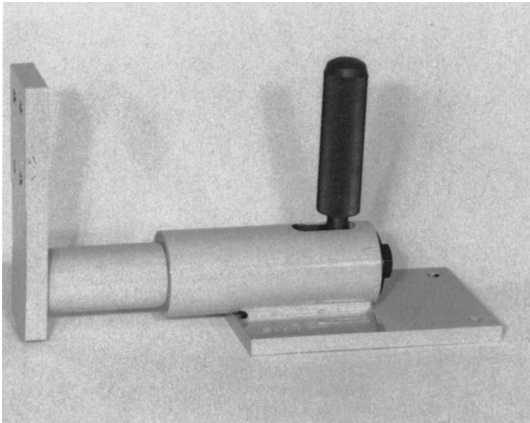
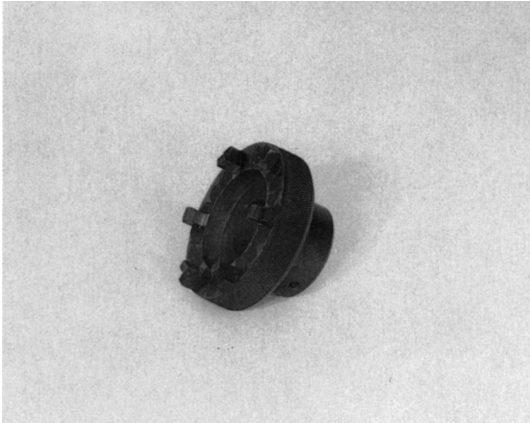

1.8 Special tools 5 HP 30

Illustr. No.		Order No. / Purpose	Remarks
7	<p data-bbox="312 360 400 394">91 196</p> 	<p data-bbox="898 367 1177 456">5 X 46 000 737 - Mandrel for fitting shaft seal, selector shaft</p>	<p data-bbox="1406 367 1517 427">Identical to 5 HP 18</p>
8	<p data-bbox="312 925 400 958">91 199</p> 	<p data-bbox="898 931 1233 992">5 X 46 000 763 - Bench holder for assembly bracket</p>	<p data-bbox="1406 931 1517 992">Identical to 5 HP 18</p>
9	<p data-bbox="312 1491 400 1525">92 208</p> 	<p data-bbox="898 1498 1102 1559">5 X 46 000 787 - Grooved nut wrench</p>	

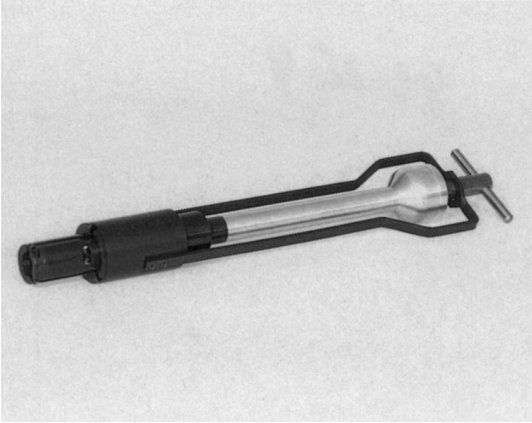
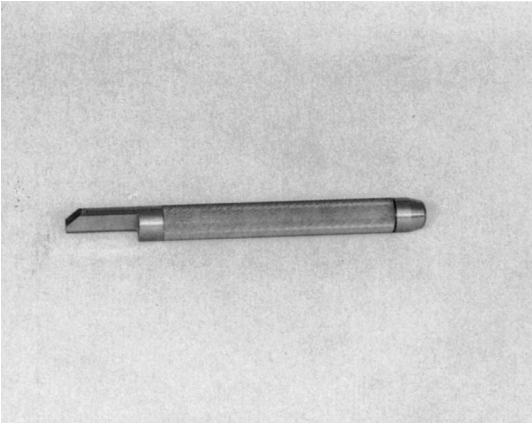
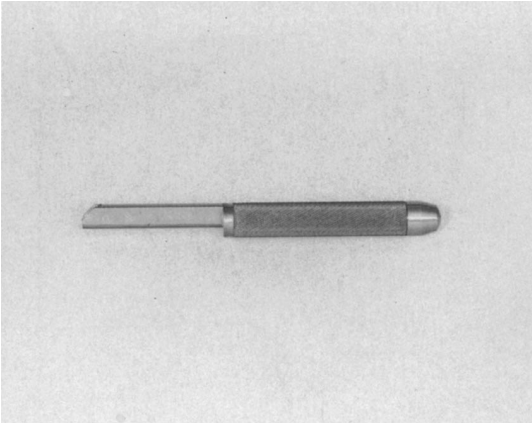
1.8 Special tools 5 HP 30

Illustr. No.		Order No. / Purpose	Remarks
10	<p data-bbox="256 360 347 394">92 209</p> 	<p data-bbox="842 367 1098 427">5 X 46 000 831 - Lifting fixture for brake F</p>	
11	<p data-bbox="256 925 347 958">92 210</p> 	<p data-bbox="842 934 1114 994">5 X 46 000 846 - Insertion tool for oil pipe II</p>	
12	<p data-bbox="256 1491 347 1525">92 211</p> 	<p data-bbox="842 1498 1106 1559">5 X 46 000 853 - Insertion tool for oil pipe I</p>	

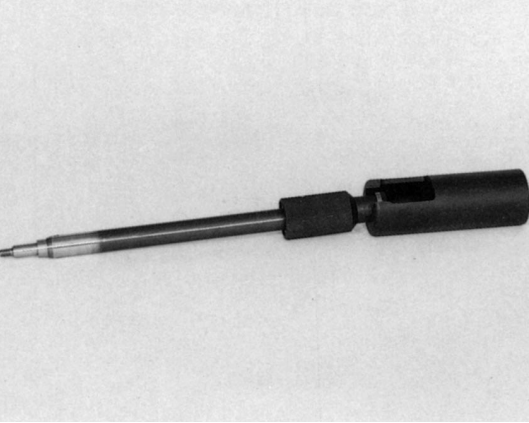
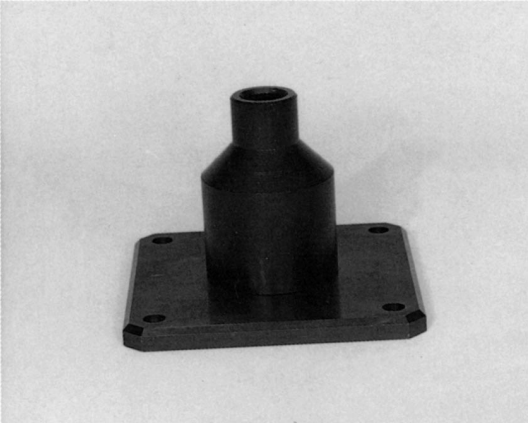
1.8 Special tools 5 HP 30

Illustr. No.		Order No. / Purpose	Remarks
13	<p data-bbox="316 360 400 394">92 212</p> 	<p data-bbox="898 369 1139 427">5 X 46 000 857 - Lifting fixture for Tower</p>	
14	<p data-bbox="316 925 400 958">92 213</p> 	<p data-bbox="898 934 1166 992">5 X 46 000 916 - Locating fixture for tower I</p>	
15	<p data-bbox="316 1491 400 1525">92 214</p> 	<p data-bbox="898 1500 1166 1559">5 X 46 000 917 - Locating fixture for tower I</p>	



1.8 Special tools 5 HP 30

Illustr. No.		Order No. / Purpose	Remarks
16	<p data-bbox="260 360 347 394">92 215</p> 	<p data-bbox="842 369 979 394">5 X 46 000 928</p> <p data-bbox="842 400 1193 461">- Assembly bracket for pressing down plate springs D, E1 and B</p>	
17	<p data-bbox="260 925 347 958">92 216</p> 	<p data-bbox="842 934 979 958">5 X 46 000 931</p> <p data-bbox="842 965 1193 1025">- Assembly bracket for pressing down plate springs F and A</p>	
18	<p data-bbox="260 1485 347 1518">91 195</p> 	<p data-bbox="842 1498 979 1523">5 X 46 000 944</p> <p data-bbox="842 1529 1158 1590">- Peening tool for clamping sleeve on selector shaft</p>	

1.8 Special tools 5 HP 30

Illustr. No.		Order No. / Purpose	Remarks
19	<p data-bbox="311 358 399 392">91 197</p> 	<p data-bbox="893 369 1029 392">5 X 46 000 945</p> <p data-bbox="893 403 1284 459">- Pressing-in fixture for ball thrust bearing. transmission extension</p>	
20	<p data-bbox="311 929 399 963">91 188</p> 	<p data-bbox="893 936 1029 958">5 X 46 000 946</p> <p data-bbox="893 969 1220 992">- Counter support for output flange</p>	
21	<p data-bbox="311 1489 399 1523">92 217</p> 	<p data-bbox="893 1500 1029 1523">5 X 46 000 949</p> <p data-bbox="893 1534 1149 1556">- Lifting fixture for tower II</p>	

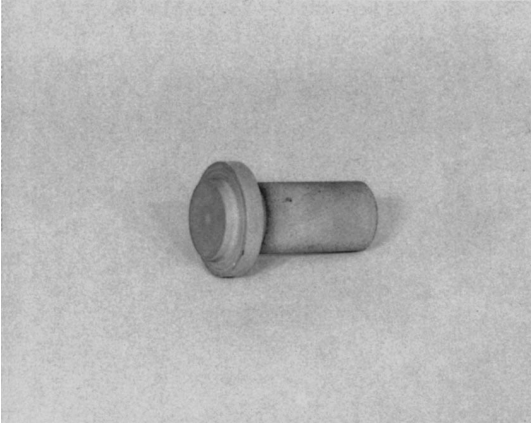
1.8 Special tools 5 HP 30

Illustr. No.		Order No. / Purpose	Remarks
22	<p data-bbox="256 360 347 394">92 218</p> 	<p data-bbox="842 369 979 394">5 X 46 000 952</p> <p data-bbox="842 400 1118 456">- Assembly drift for shaft seal extension</p>	
23	<p data-bbox="256 925 347 958">92 219</p> 	<p data-bbox="842 934 979 958">5 X 46 000 953</p> <p data-bbox="842 965 1139 1021">- Assembly sleeve for shaft seal on pump</p>	
24	<p data-bbox="256 1489 347 1523">92 220</p> 	<p data-bbox="842 1498 979 1523">5 X 46 000 954</p> <p data-bbox="842 1529 1169 1585">- Assembly drift for needle bearing on pump</p>	

1.8 Special tools 5 HP 30

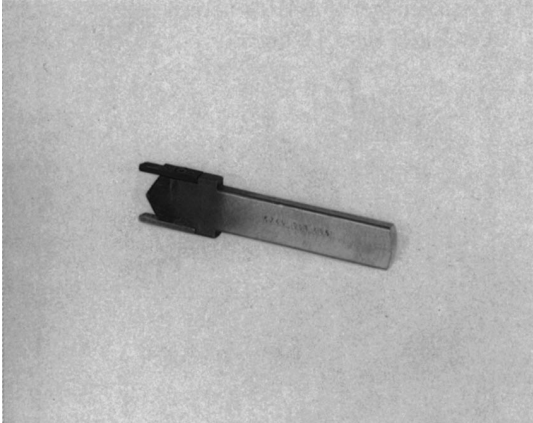
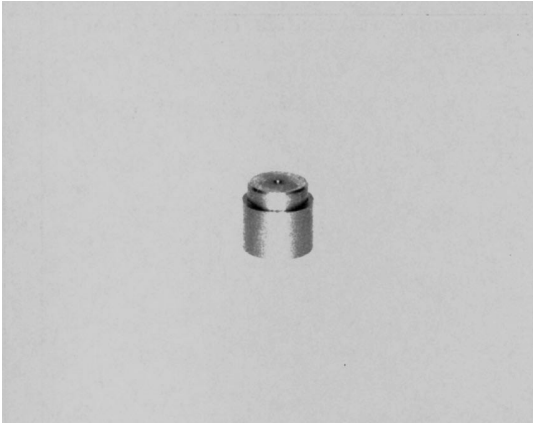
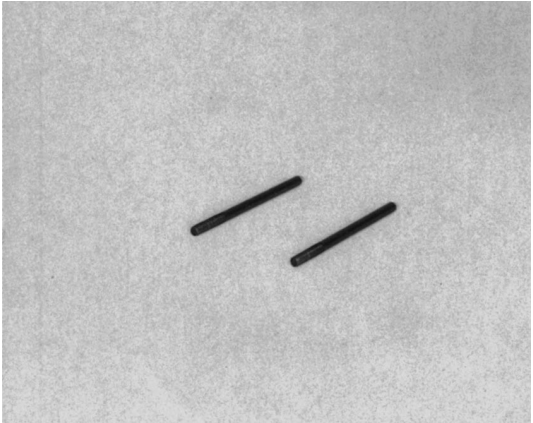
Illustr. No.		Order No. / Purpose	Remarks
25	<p data-bbox="312 360 400 394">92 221</p> 	<p data-bbox="898 369 1209 427">5 X 46 001 005 - Bending fixture for pot, tower II</p>	
26	<p data-bbox="312 925 400 958">92 222</p> 	<p data-bbox="898 934 1222 1025">5 X 46 001 006 - Assembly drift for needle bearing on cylinder F</p>	
27	<p data-bbox="312 1491 400 1525">92 223</p> 	<p data-bbox="898 1498 1267 1556">5 X 46 001 007 - Locating pins (2 off) for oil supply unit</p>	

1.8 Special tools 5 HP 30

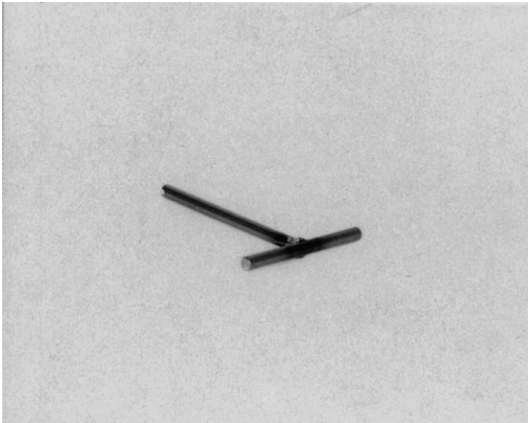
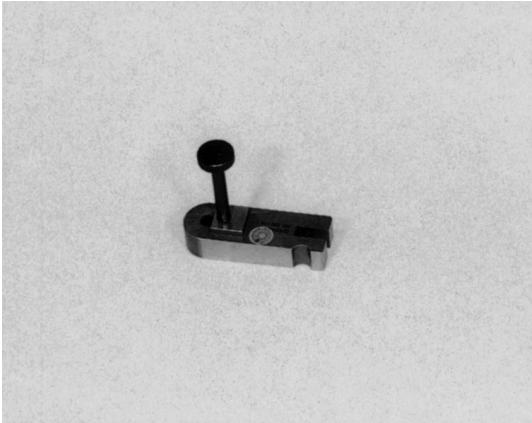
Illustr. No.		Order No. / Purpose	Remarks
28	<p data-bbox="260 360 347 394">92 224</p> 	<p data-bbox="842 367 979 394">5 X 46 001 064</p> <p data-bbox="842 400 1171 461">- Assembly hoop for pressing down plate springs E2 and C</p>	
29	<p data-bbox="260 925 347 958">92 239</p> 	<p data-bbox="842 934 979 960">5 X 46 001 084</p> <p data-bbox="842 967 1187 994">- Disassembly tool for pot in tower II</p>	
30	<p data-bbox="260 1491 347 1525">92 240</p> 	<p data-bbox="842 1498 979 1525">5 P 01 002 368</p> <p data-bbox="842 1532 995 1559">- Position gauge</p>	

1.8 Special tools 5 HP 30

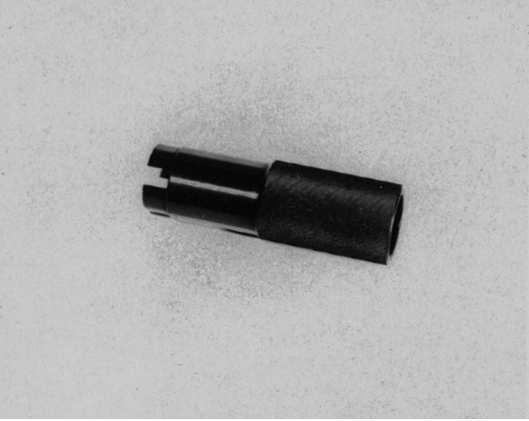
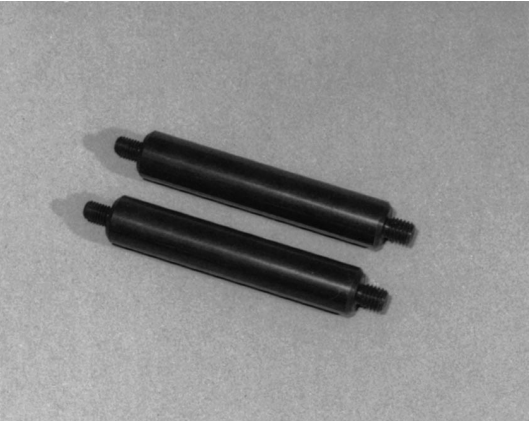
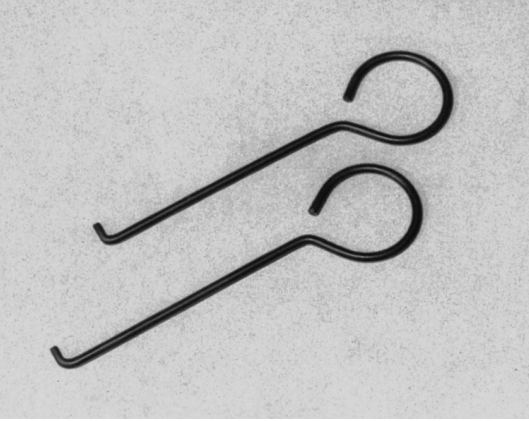
Illustr. No.		Order No. / Purpose	Remarks
31	<p data-bbox="316 360 400 394">76 047</p> 	<p data-bbox="898 371 1145 461">5 X 56 000 021 - Sleeve to check easy in rotation of pump gears</p>	<p data-bbox="1414 371 1493 488">Identical 3 HP 22 4 HP 22 5 HP 18</p>
32	<p data-bbox="316 925 400 958">76 046</p> 	<p data-bbox="898 936 1082 992">5 X 56 000 090 - Mounting grips (2)</p>	<p data-bbox="1414 936 1493 1052">Identical 3 HP 22 4 HP 22 5 HP 18</p>
33	<p data-bbox="316 1496 400 1529">76 045</p> 	<p data-bbox="898 1507 1058 1563">5 X 56 000 095 - Puller hooks (2)</p>	<p data-bbox="1414 1507 1493 1585">Identical 3 HP 22 4 HP 22</p>

2. Dismantling

2.1 Dismantling the transmission by assembly group

Place the complete transmission in assembly clamp 5 X 46 000 635, and drain off oil.

It is recommended to unscrew the oil drain and the oil fill plugs for this purpose.

Oil drain plug = Allen screw,
14 mm across flats

Oil fill plug = Allen screw,
17 mm across flats

Note!

If necessary, use bench holder
5 X 46 000 763.

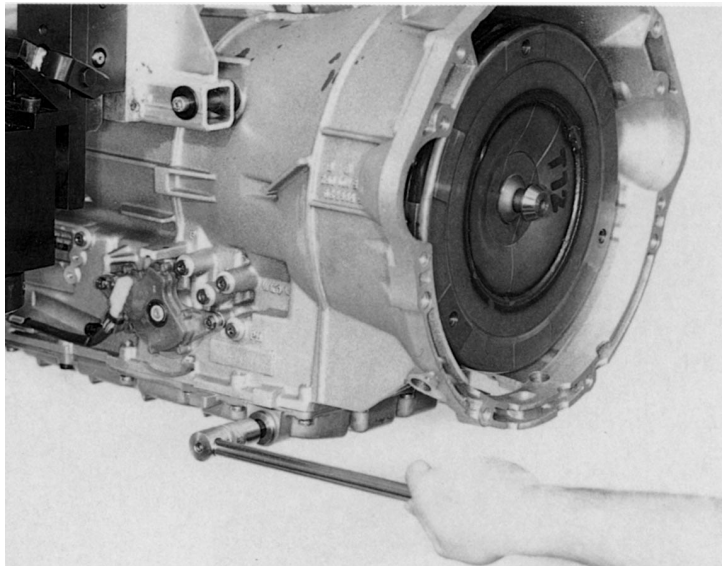

Remove the converter retaining hoop and pull out the converter by screwing in the two handles 5 X 56 000 090.

Warning!

Oil will escape. Avoid damage to converter bearings and shaft sealing ring on pump.

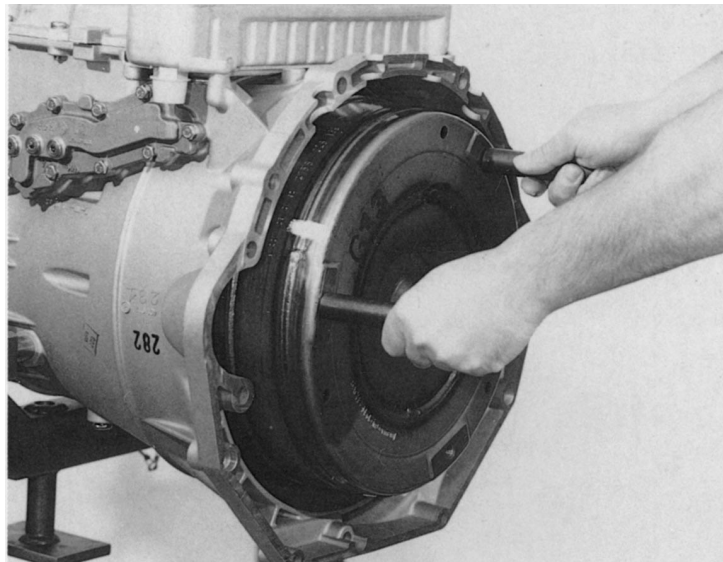

Rotate transmission through 180 degrees. Remove 4 machine screws securing the oil cooler together with 2 O-rings.

(Wrench size = Torx - TX 27)

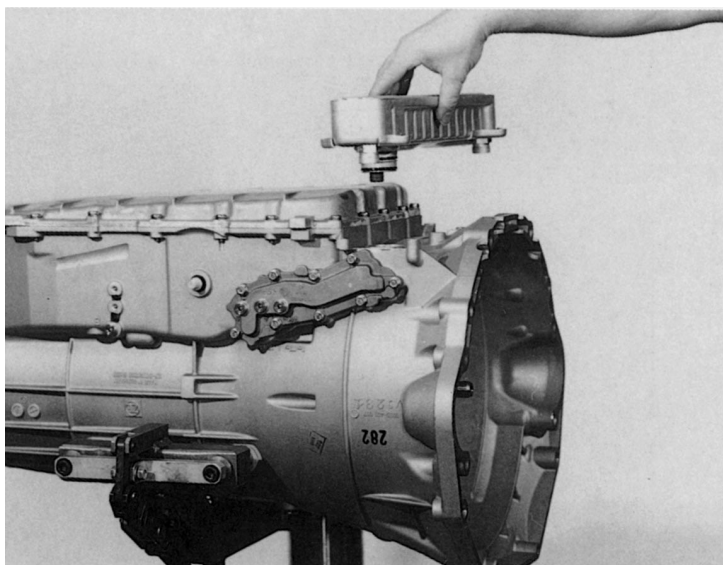

92 229

Remove bracket by loosening the machine screw.

(Wrench size = Torx socket wrench insert TX 27.)

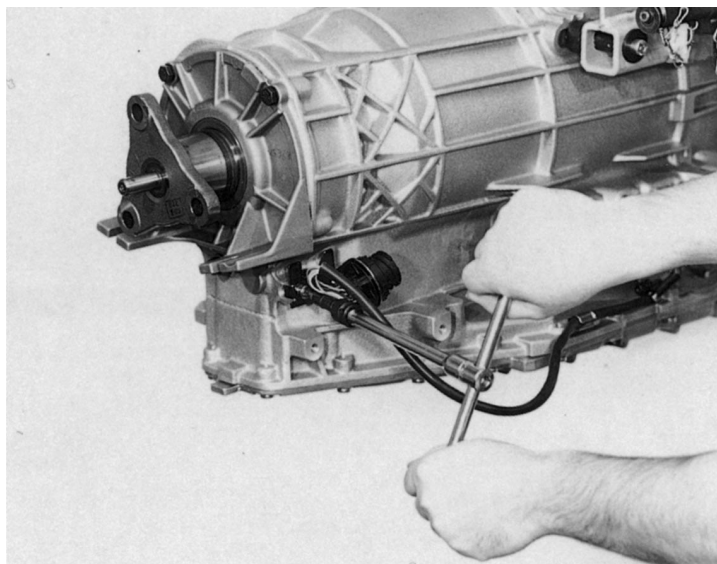

92 230

Lever out cable from cable clip using screwdriver.

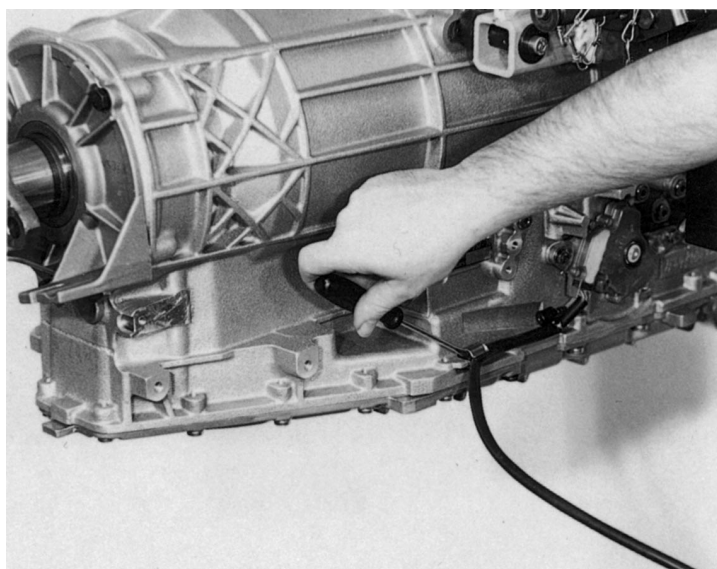

92 231

Unscrew two hex screws and lift out switch.

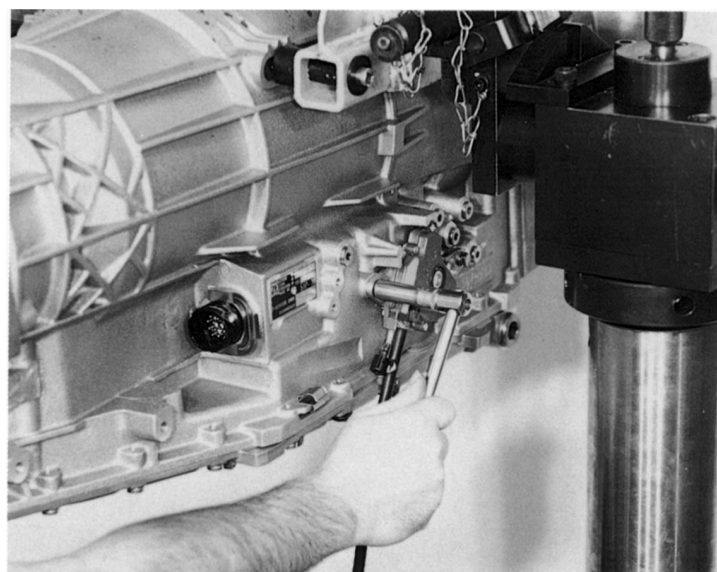

92 004

Remove 23 machine screws securing the oil sump, lift off oil sump cover and gasket.

(Wrench size = Torx socket head TX 27)

Caution!

Remove remains of gasket from sealing face.

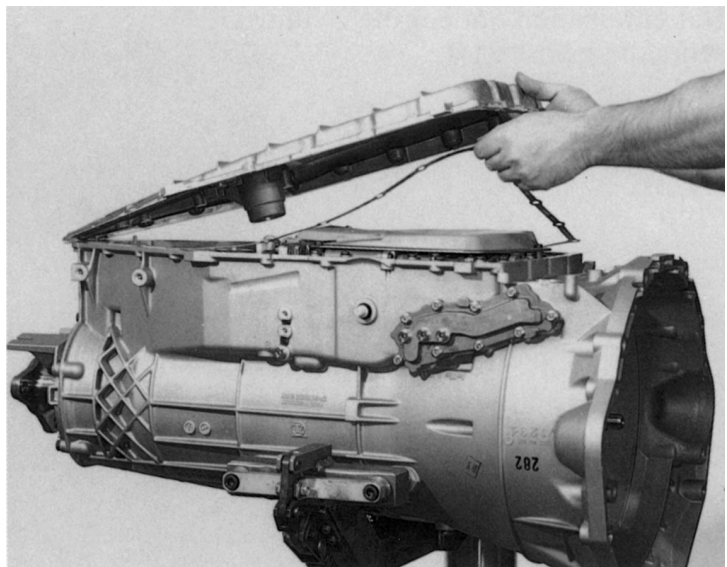

92 005

Remove oil container with magnet. Remove filter and O-ring, unscrewing two machine screws before doing so.

(Wrench size = Torx socket head TX 27)

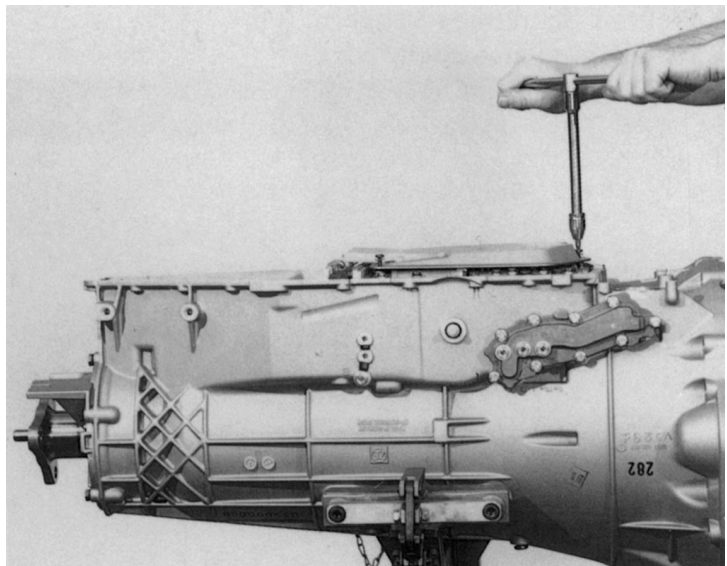

92 006

Remove cable harness from transmission housing.

To do this, unscrew bracket from guide plate and release retaining brackets on plug using a suitable screwdriver.

(Wrench size = width across flats = 13 mm)

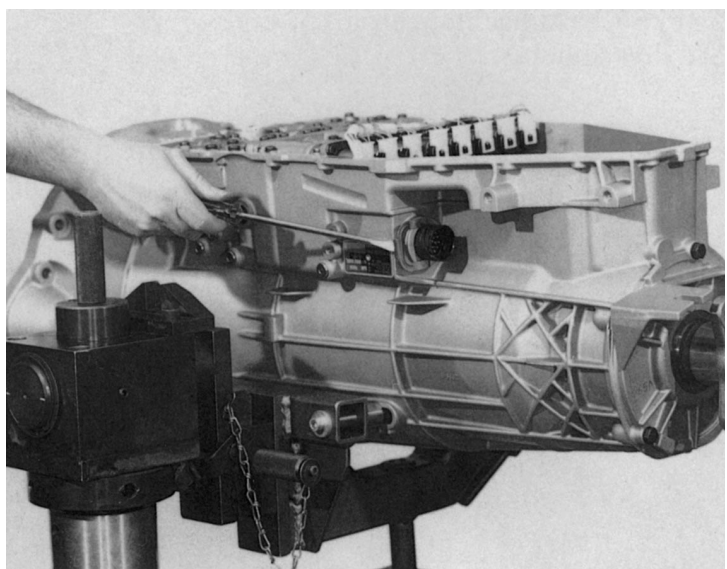

92 007

Remove all screws with larger wrench head (12 off) and lift off complete unit with suction and pressure pipes.

(Wrench size = Torx socket head TX 27)

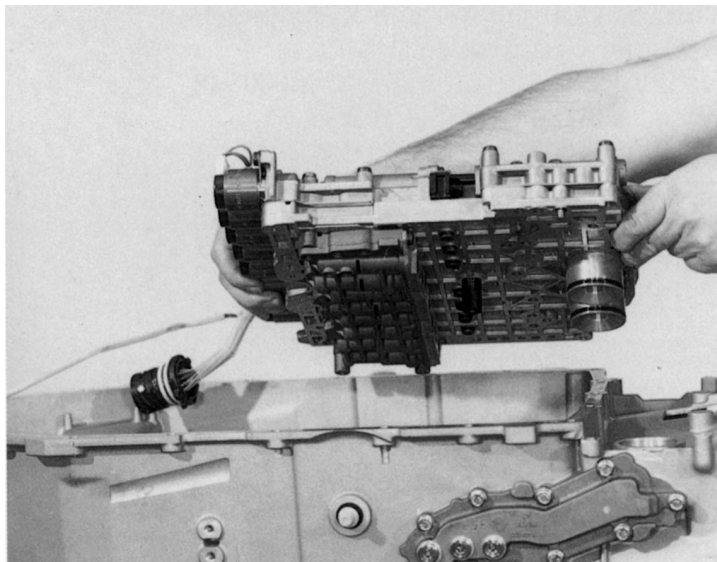

92 008

Rotate transmission through 90 degrees and remove oil supply unit (consisting of pump, intermediate plate and stator shaft), removing 12 machine screws (M6 x 40 mm) and 2 machine screws (M6 x 65 mm) with Usit ring to do so.

(Wrench size = Torx socket head TX 27)

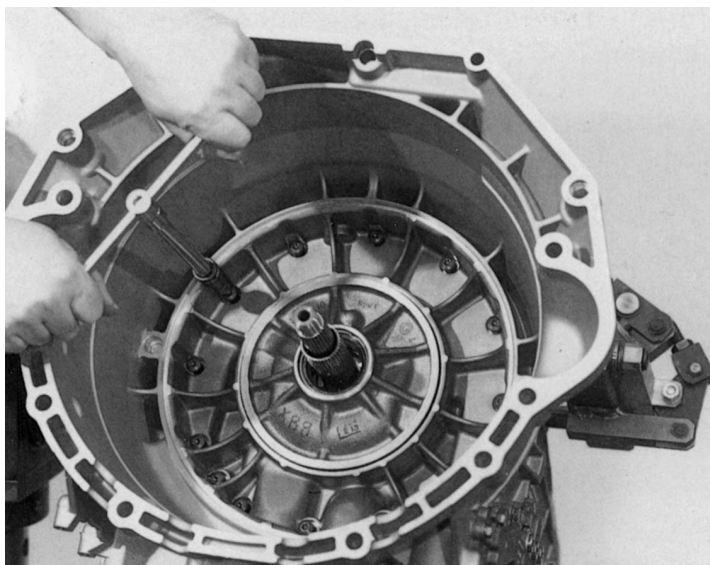

92 009

Attach assembly fixture 5 X 46 000 563 to stator shaft and release and remove entire unit by rotating spindle of fixture.

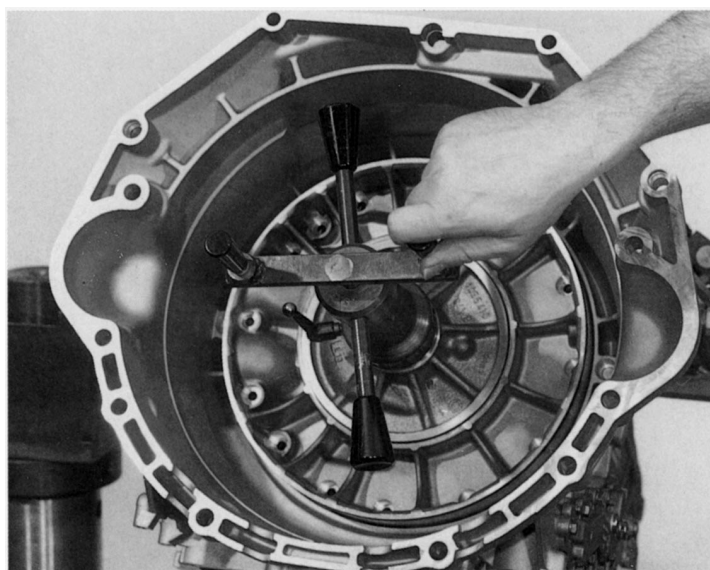

Remove tower II (input section with clutches A, B and C).
 Use lifter 5 X 46 000 949 for this, bolted to adapter 5 W 46 000 003 and attached to the input shaft.
 Lift out the complete unit with a crane and place in locating fixture 5 X 46 000 917.

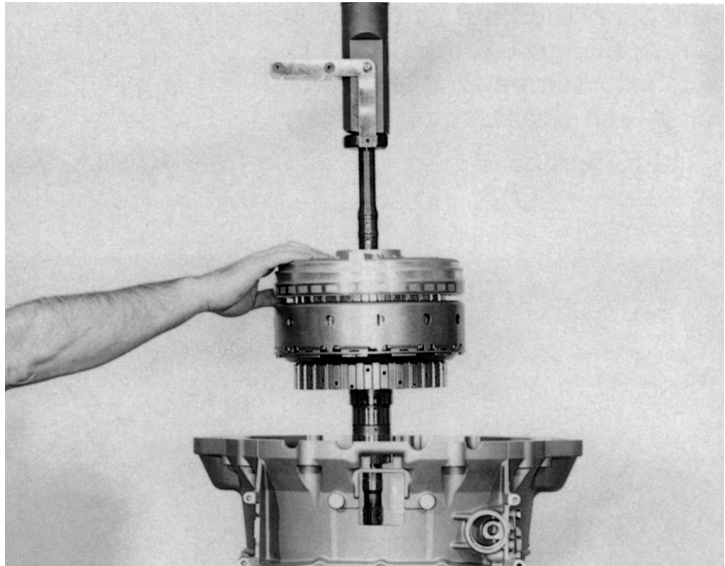

In order to remove tower I (planetary drive and brakes D, E1, and E2), first unscrew the 3 machine screws.
 (Wrench size = Torx socket head TX 50)

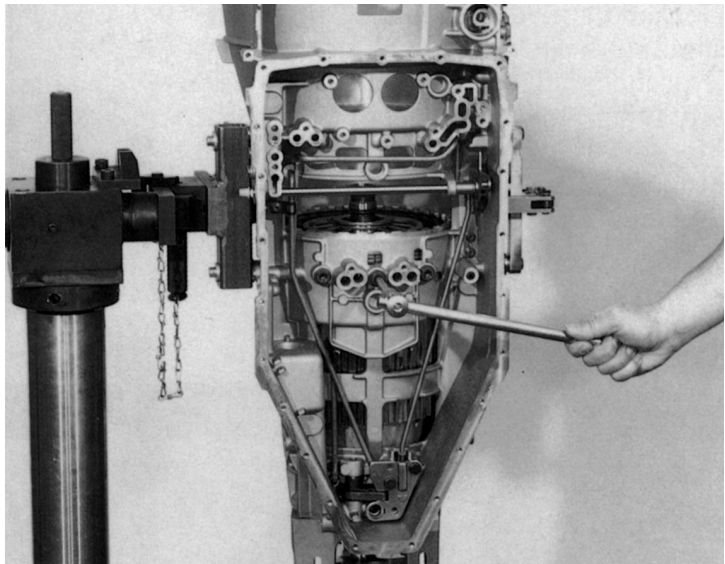

Screw lifter 5 X 46 000 857 into the planet carrier of the tower and lift out the complete unit with a crane. Insert tower I in locating fixture 5 X 46 000 916. Remove lifter.

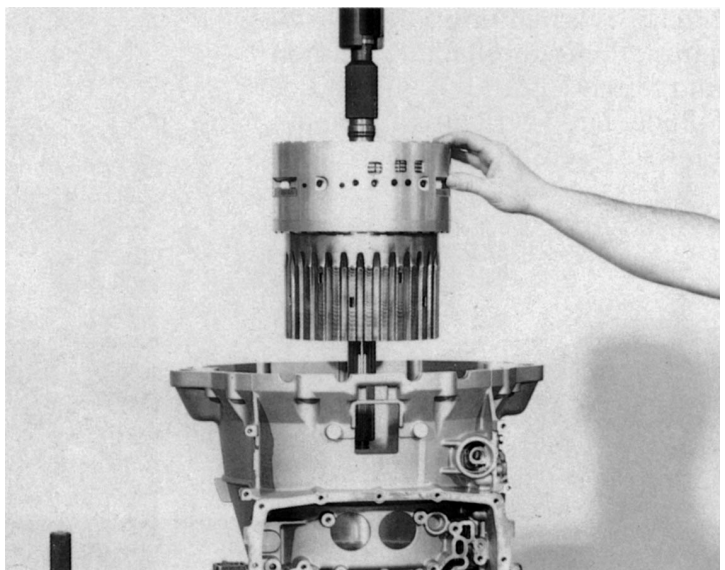

Rotate transmission through 180 degrees and unfasten the 5 hex screws. At this point, the entire output section can be removed.

(Size of wrench = 13 mm across flats)

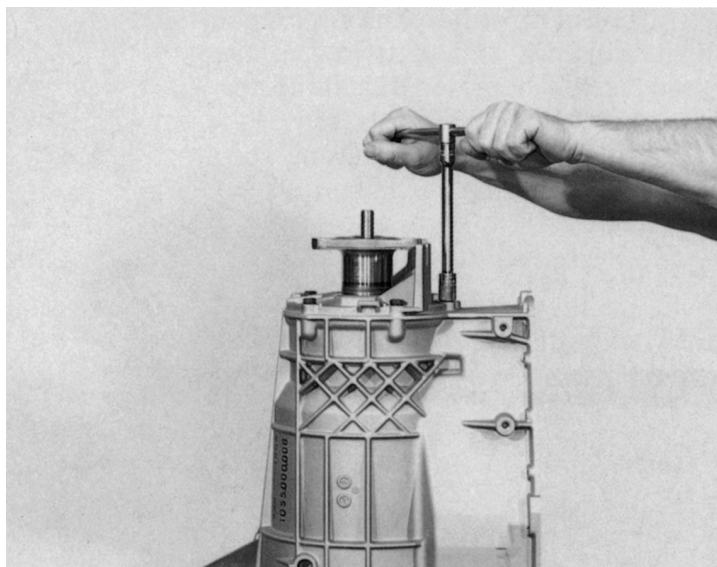

Remove shim and parking pawl gear from transmission housing.

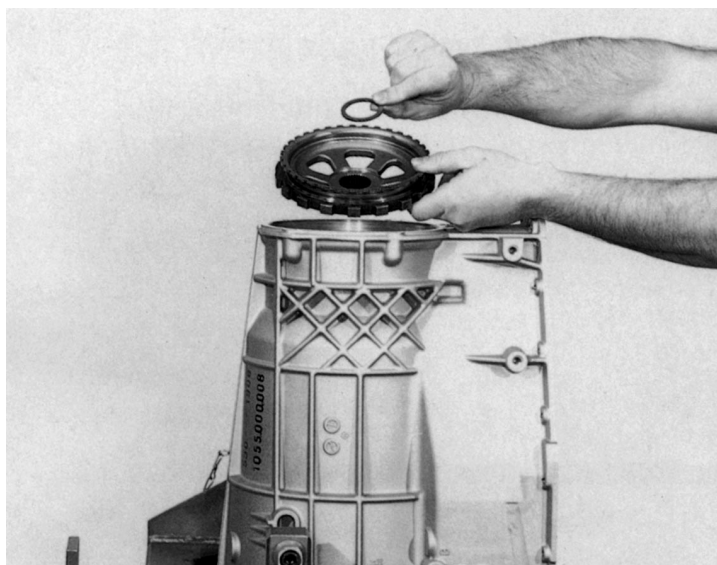

Rotate transmission through 90 degrees and remove the 12 countersunk screws securing cylinder F.

(Size of wrench = Torx - TX 40)

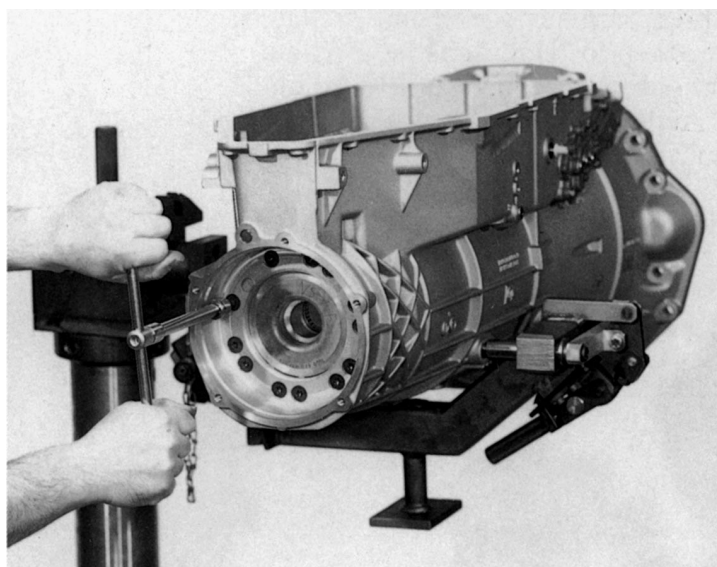

Rotate transmission through 90 degrees and insert lifter 5 X 46 000 83 1 in cylinder F by lifting bracket handle. The fixture is locked by releasing the bracket handle. Rotate fixture until it locates.

Caution!

Do not lift using bracket handle! Lift out using hand grip on cylinder F.

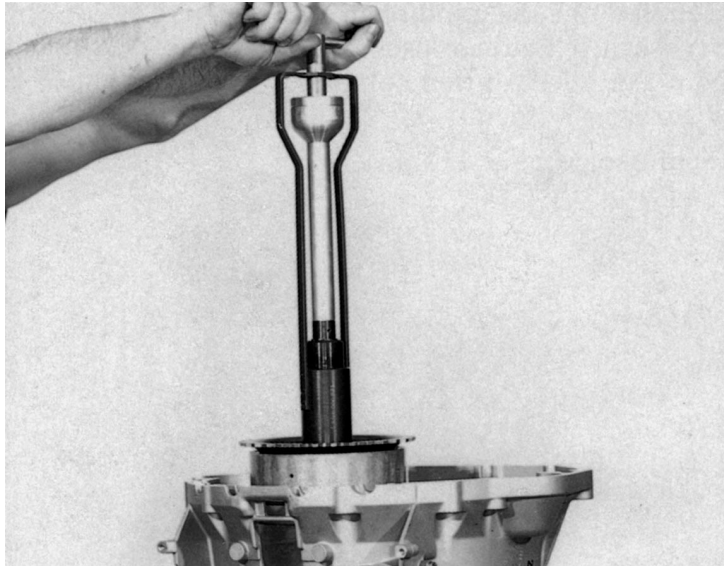

2.2 Brake F + freewheel, 1st gear

The freewheel unit can be completely detached from cylinder F. For this, extract snap ring using suitable pliers and a screwdriver.

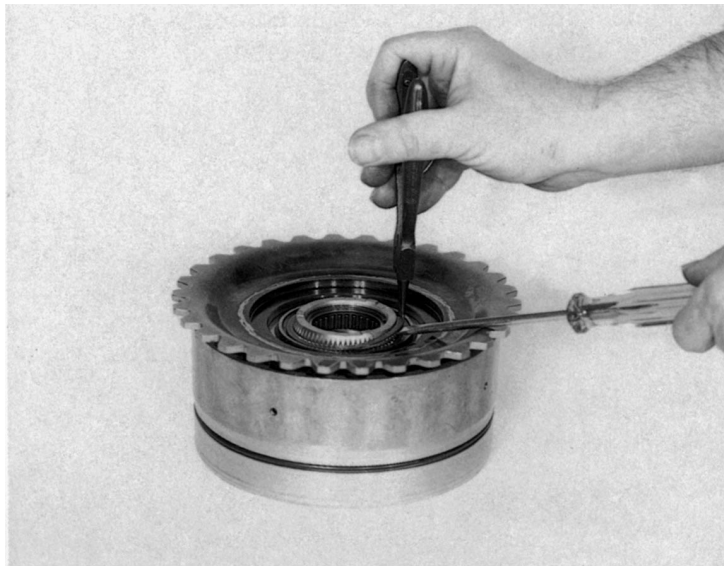

Extract snap ring and dismantle freewheel into retaining disc, freewheel inner race, complete freewheel unit (cage and 2 washers) and complete freewheel race F.

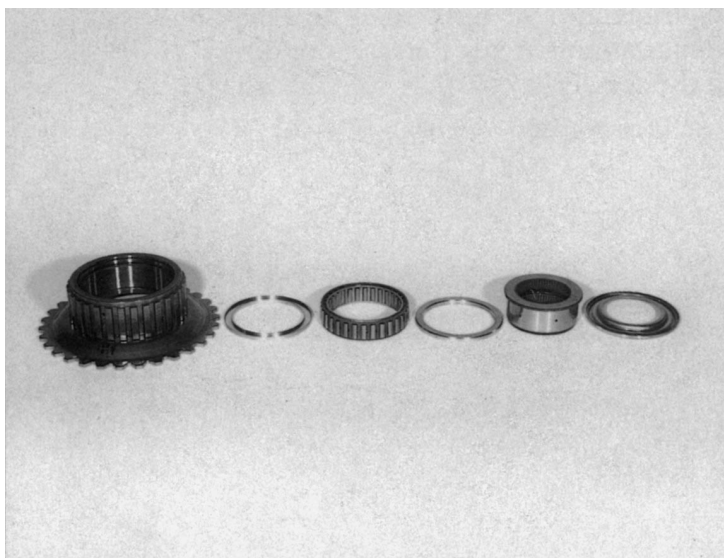

92 019

Extract snap ring and remove complete disc pack of brake F.

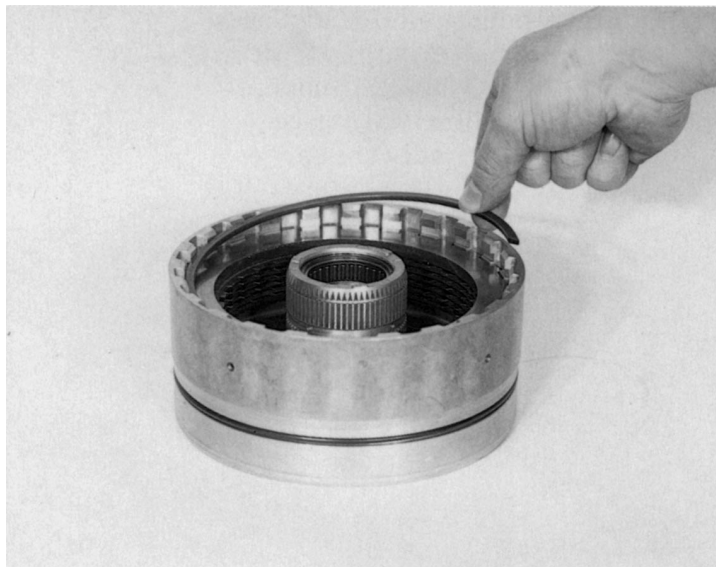

92 020

Remove O-ring from cylinder F, press down plate spring under mandrel press with assembly bracket 5 X 46 000 931 and remove the split ring. Remove plate spring.

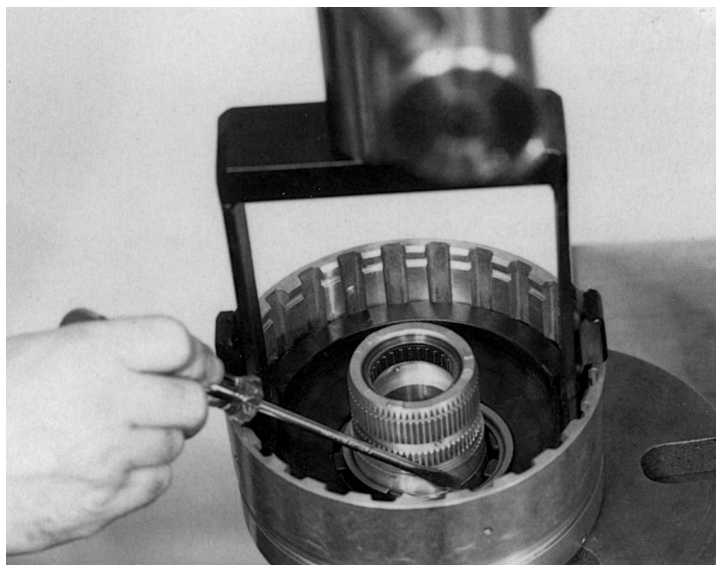

92 021

Use two plastic drifts to drive piston out of cylinder F.

Caution!

Store piston in a way which avoids damage to, or folding of, the sealing lip.

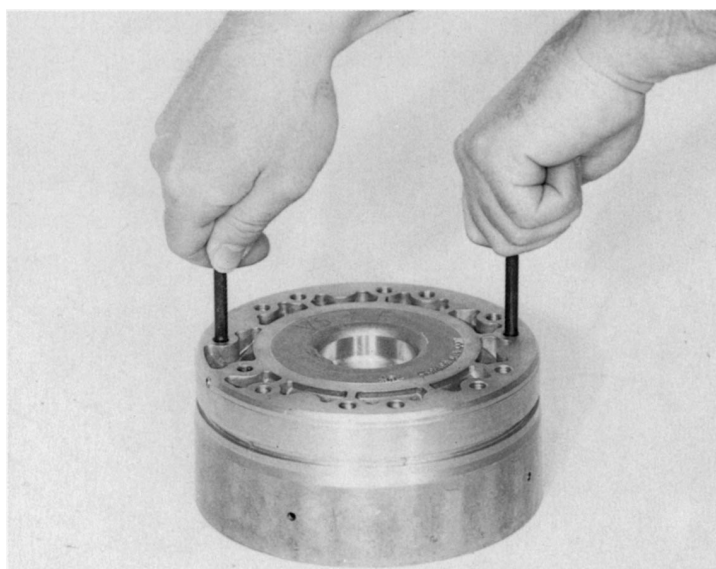

Extract snap ring and drive needle bearing out of cylinder hub using suitable mandrel. If necessary, use assembly bracket 5 X 46 000 931 as support.

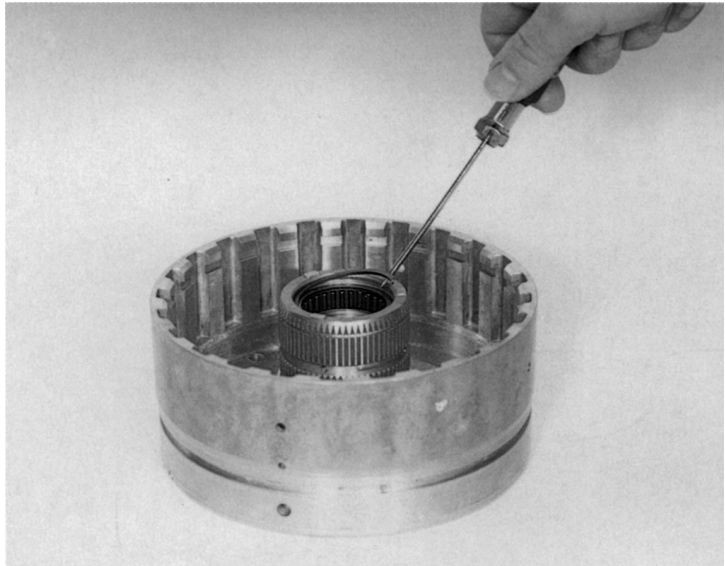

2.3 Output

Place output section on counter-support 5 X 46 000 946 and clamp retaining fixture in vise.

Caution!

Different versions are possible.
Remove O-ring from extension.



Release grooved nut by striking with chisel and unscrew using slotted nut insert 5 X 46 000 787.

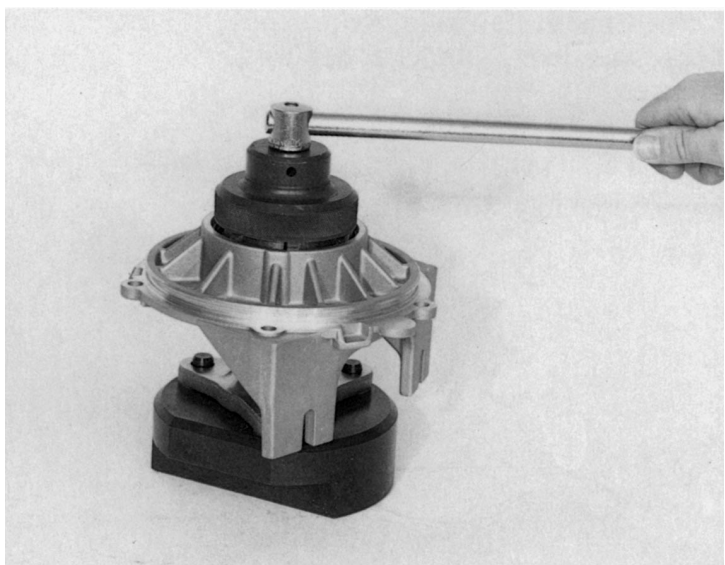

Extract snap ring with pliers and lift extension off output flange. Then press out ball bearing and shaft seal using mandrel press.

If necessary, heat extension with hot air blower to approx. 70 degrees Celsius.

Caution!

The two inner bearing races must not be accidentally interchanged.

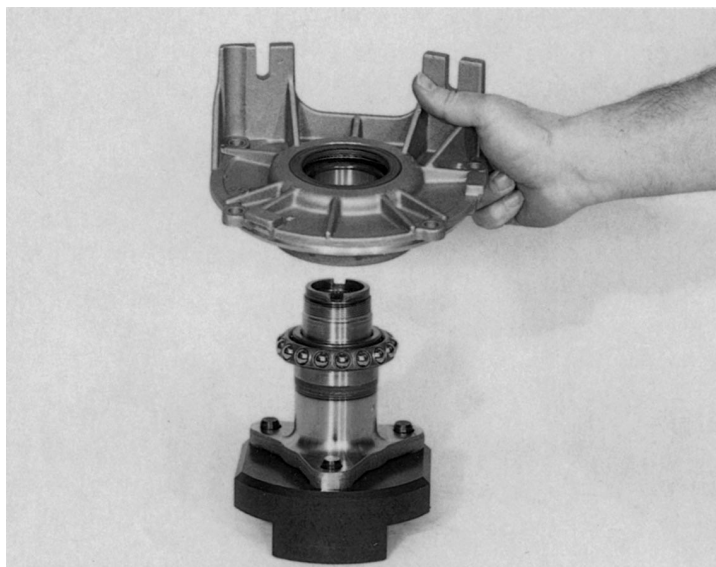

2.4 Tower 1

2.4.1 Brakes D, E1, E2 and freewheel unit on 2nd gear

Place tower I in locating fixture 5 X 46 000 916. Remove axial needle bearing and complete cylinder D/E.

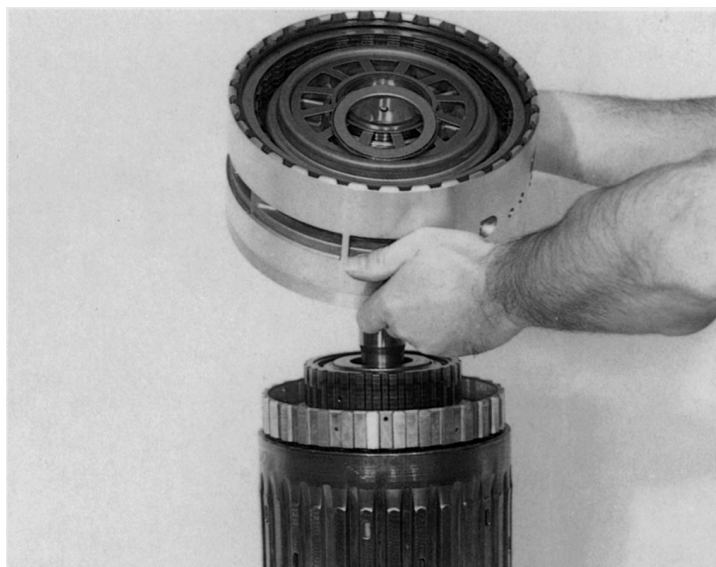

Extract snap ring from brake D and remove complete disc pack.

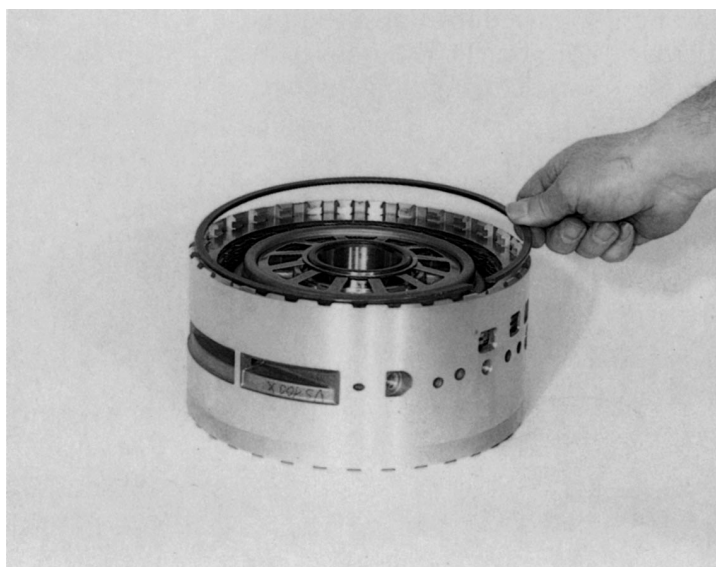

92 028

Using assembly bracket 5 X 46 000 928, press down plate spring D under mandrel press, remove split retaining ring and lift out plate spring.

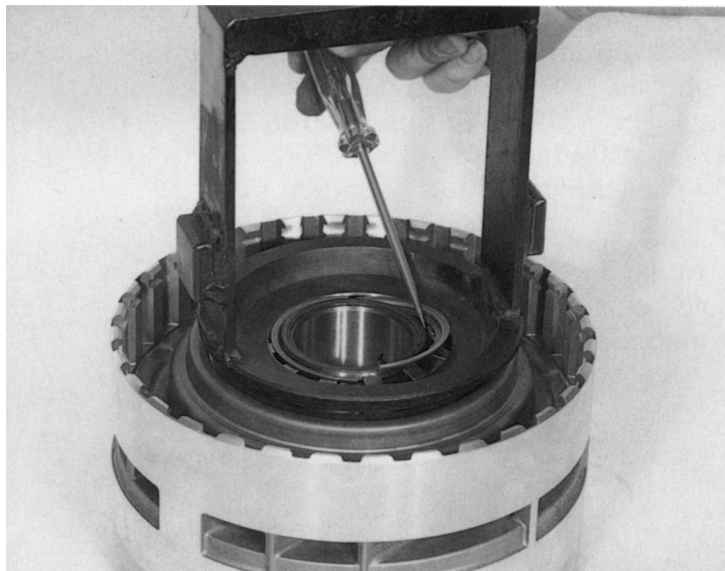

92 029

Apply a compressed air jet to the oil feed bore and force out piston D by building up the necessary air pressure. Remove O-ring from cylinder.

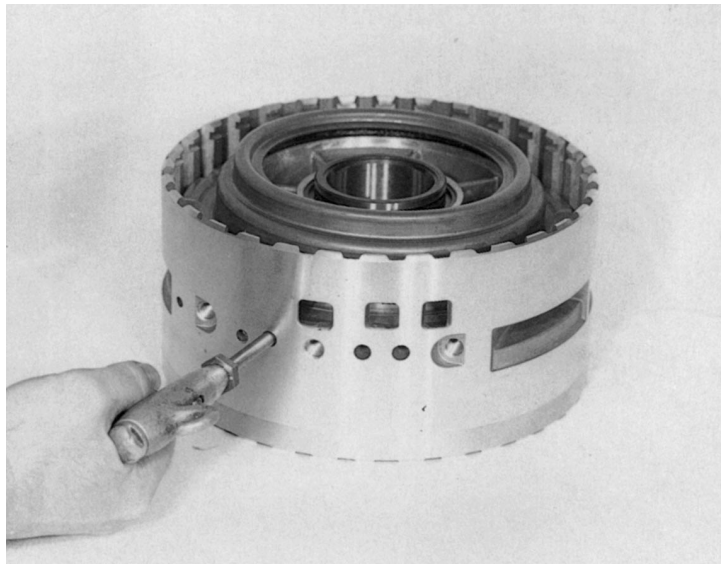

92 030

Extract the snap ring and remove bush from cylinder D/E. Remove 2 O-rings from bush.

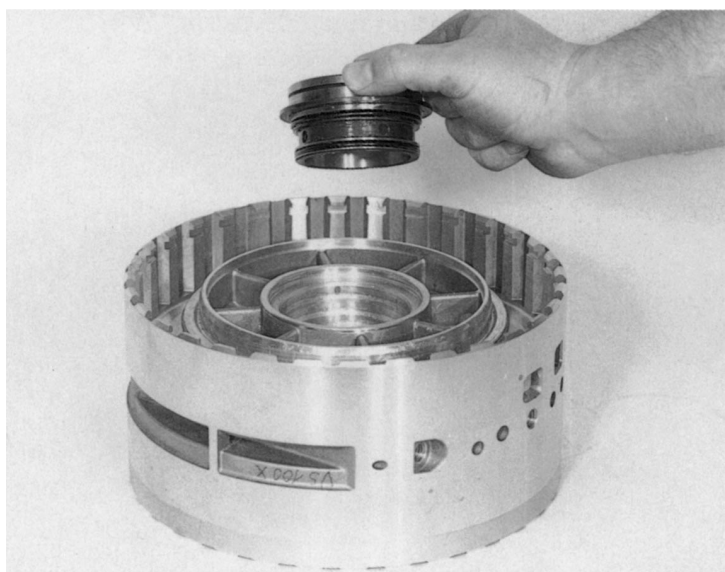

92 031

Extract snap ring from brake E2 and remove complete disc pack.

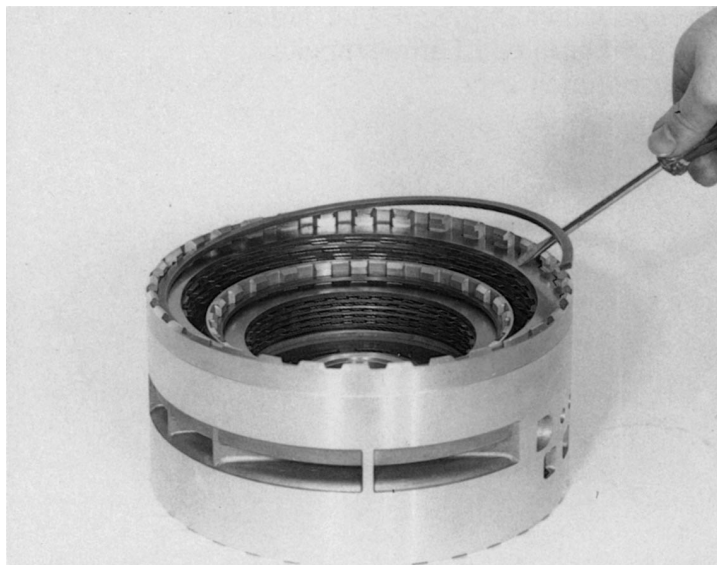

92 032

Using assembly bracket 5 X 46 001 064, press out plate spring E2 under mandrel press. Press down retaining ring and extract snap ring using a suitable screwdriver. Remove retaining ring and plate spring.

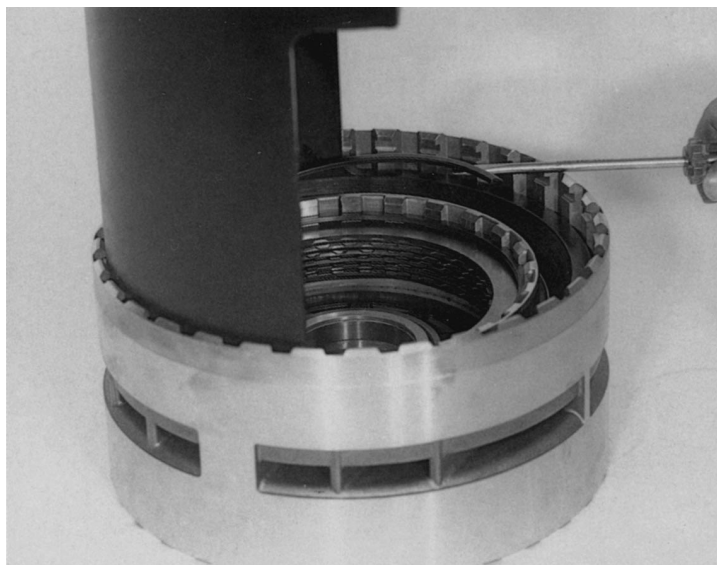

92 033

Press out piston E2 by applying compressed air jet to the oil supply bore. Remove both O-rings from the piston.

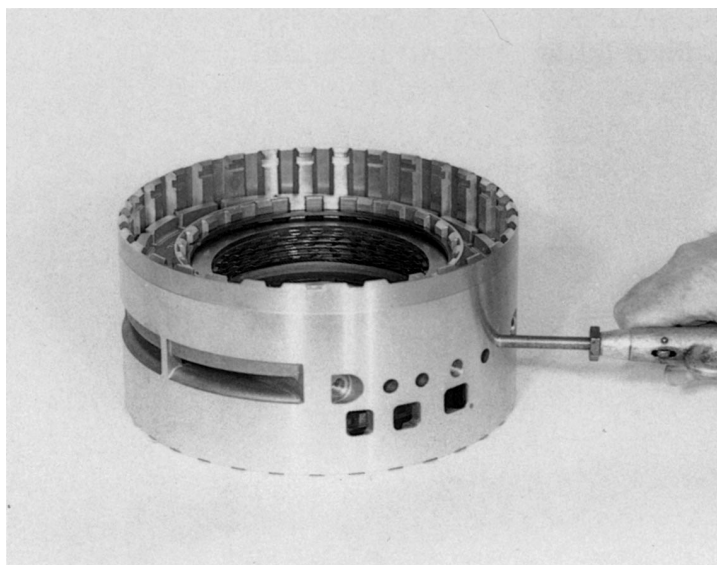

92 034

Extract snap ring from brake E1 and remove complete disc pack.

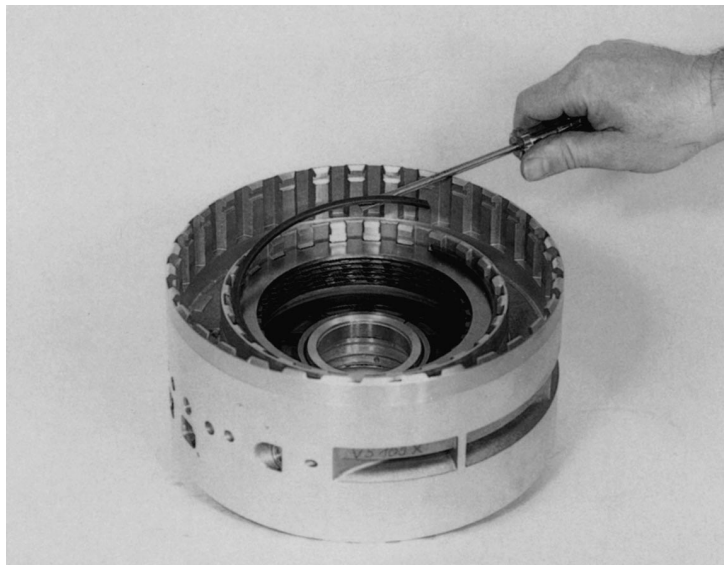

92 035

Using assembly bracket 5 X 46 000 928, press down plate spring E1 under mandrel press, remove split ring and lift out plate spring.

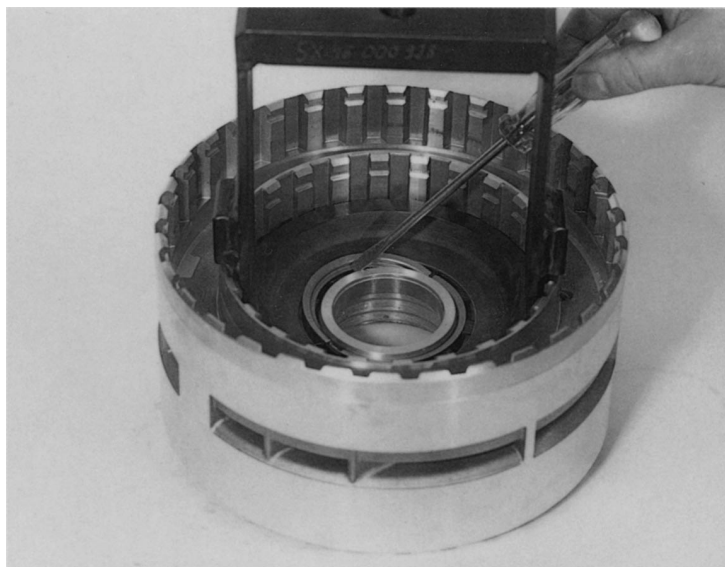

92 036

Apply a compressed air jet to the oil feed bore and press out piston E1 by means of the air pressure.

Caution!

Set the piston down so that the sealing lip is not damaged or folded over.

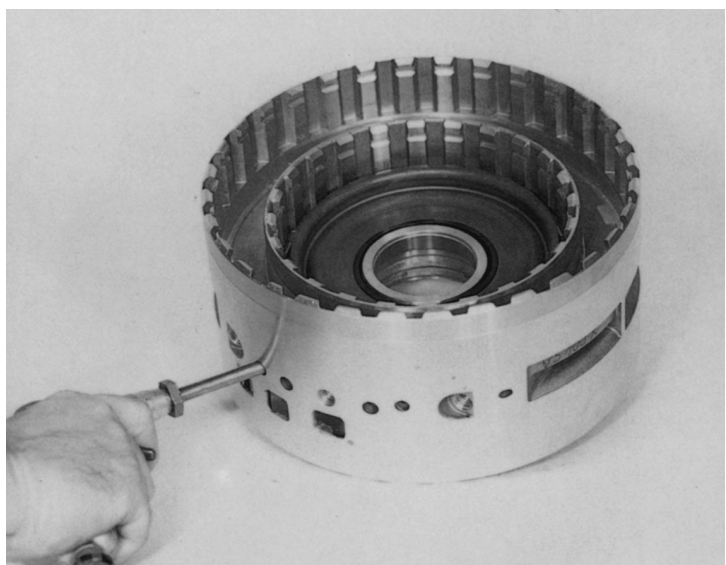

Lift off angled disc and axial needle bearing cage.

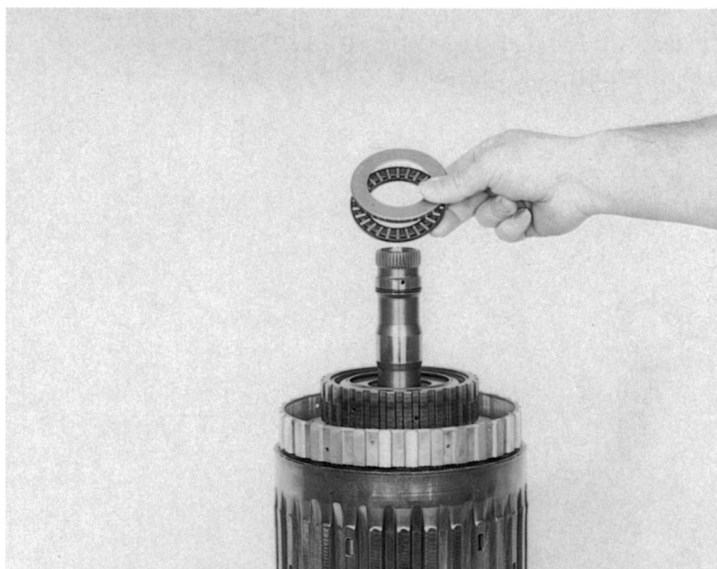

Lift off complete freewheel unit for 2nd gear. Once the snap ring has been extracted, the freewheel can be dismantled for cleaning: retaining disc, axial thrust washer, freewheel inner race, freewheel cage with two washers and outer race.

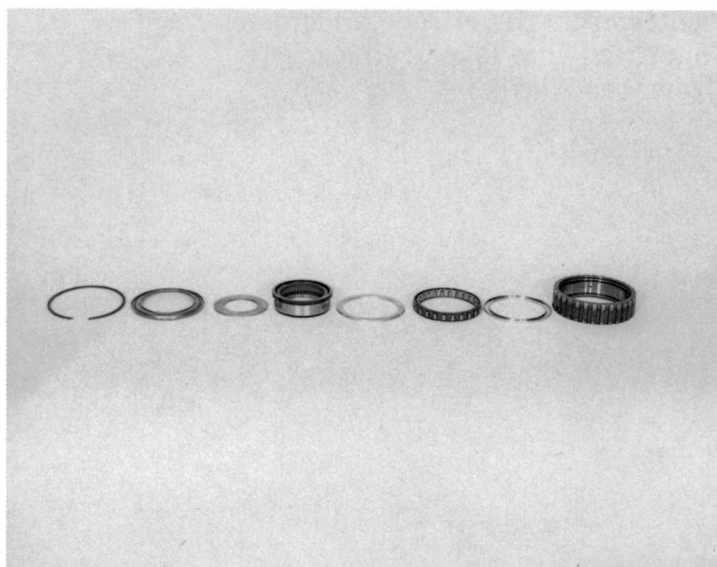

Using two screwdrivers, lift off planet carrier E2.

Caution!

Tilt edge of screwdriver upwards.

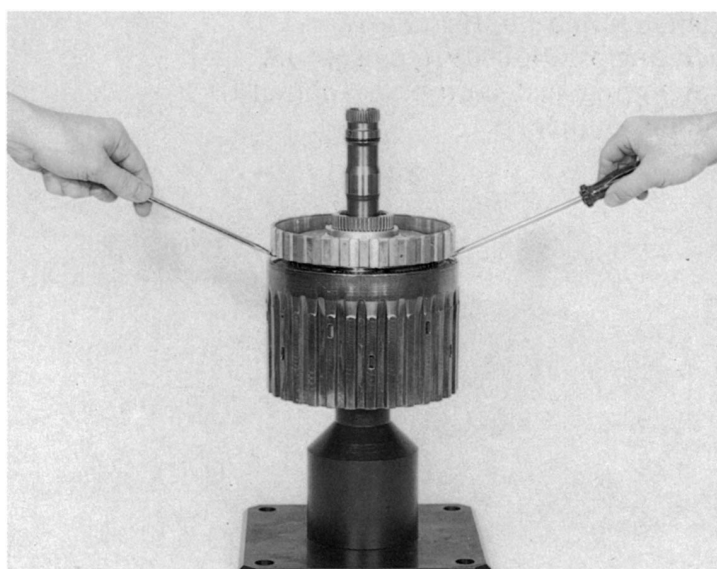

2.4.2 Planetary drive (III, II and I)

92 225

Lift planetary drives I + II off planetary drive III.

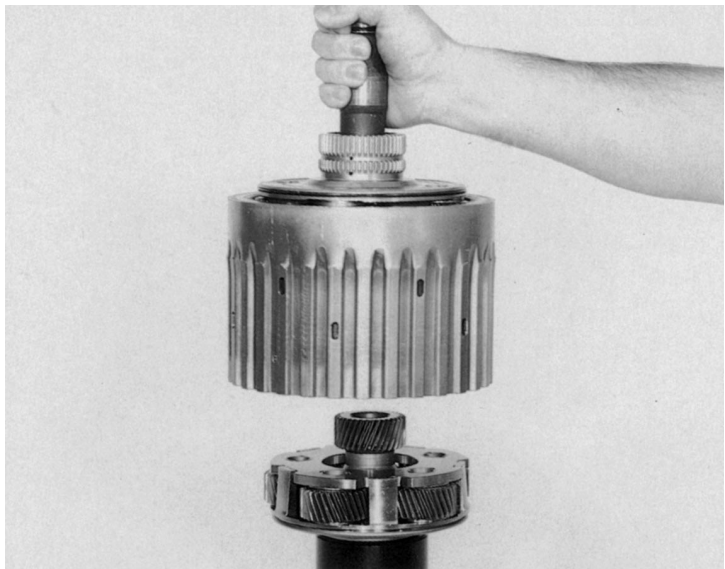

Dismantle planetary drive III by lifting sun gear off planet carrier III.

92 226

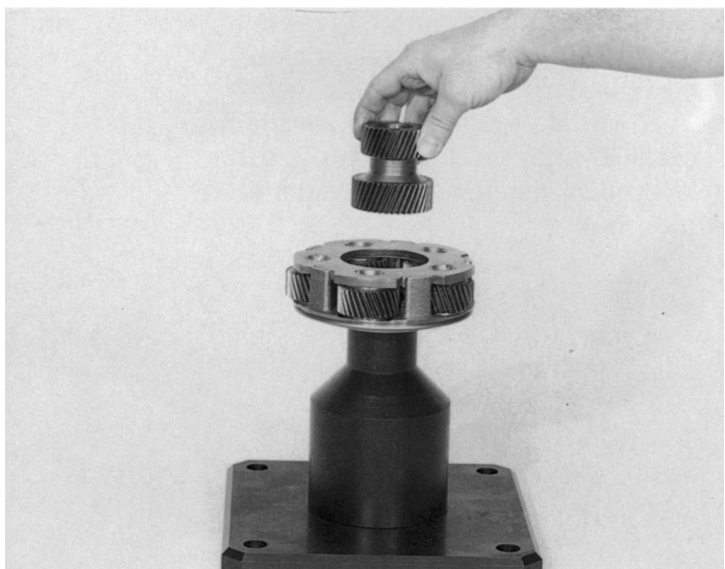

Place planetary drives I + II in fixture 5 X 46 000 916. Extract snap ring and remove ring gear III.

92 227

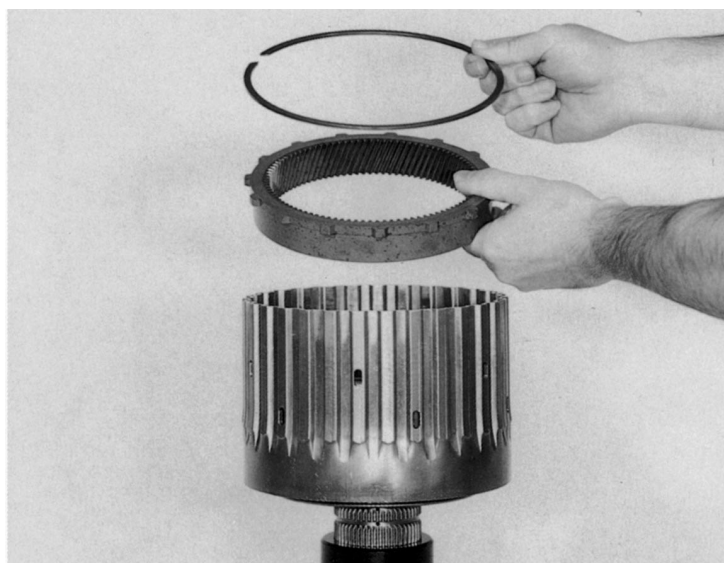

92 040

Remove planet carrier II and extract round seal from shaft.

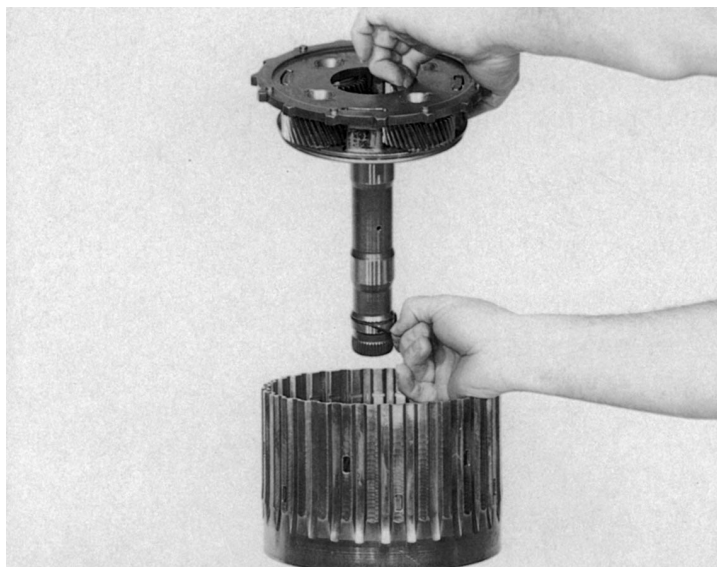

92 041

Remove axial thrust washer, axial needle cage and angled disc. Lift out sun gear.

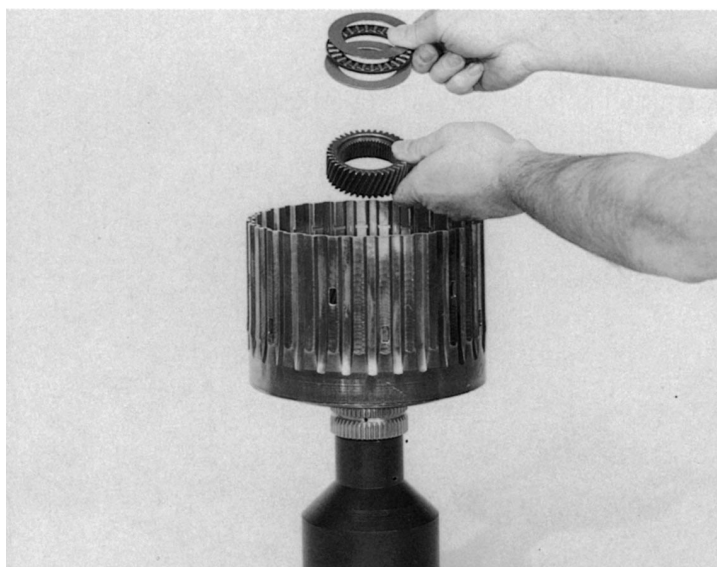

92 042

Extract snap ring and separate planet carrier I and ring gear II from ring gear I.

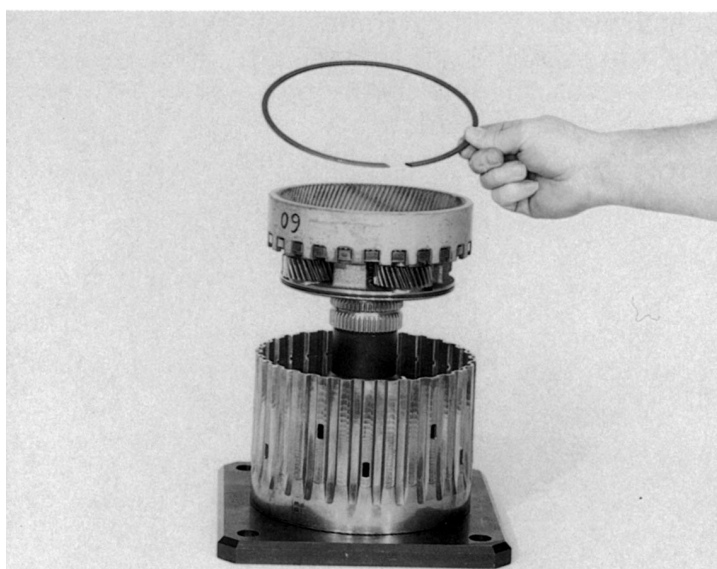

To separate ring gear II from planet carrier I, first extract the snap ring. Remove O-ring from planet carrier I.

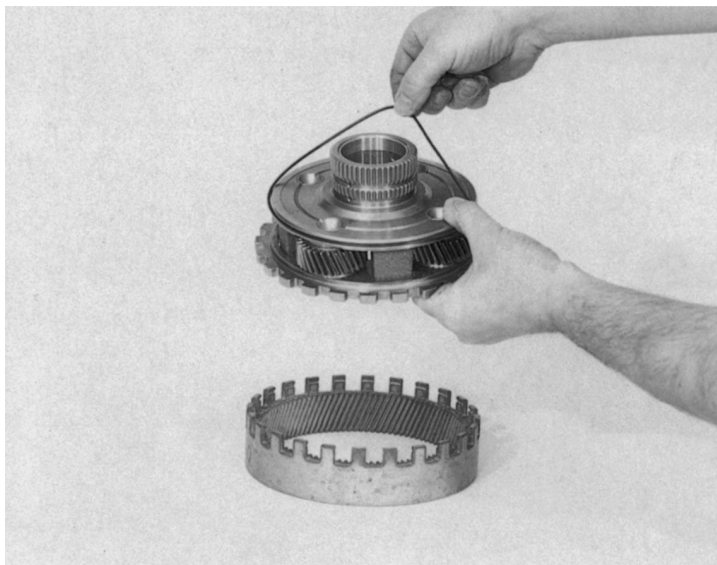

2.5 Tower II

(input unit with clutches A, C and B)

Take out the shim, axial needle cage and angled disc and lift complete tower out of fixture 5 X 46 000 917, rotate through 180 degrees and replace in the same fixture.

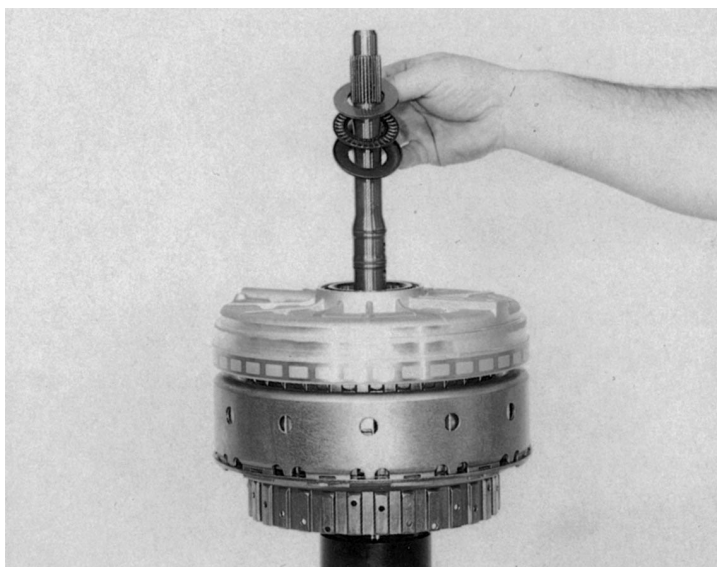

Release disc carrier C using disassembly tool 5 X 46 001 084 at six points around the circumference of the pot and lift out sun gear.

Remove both rectangular section rings.

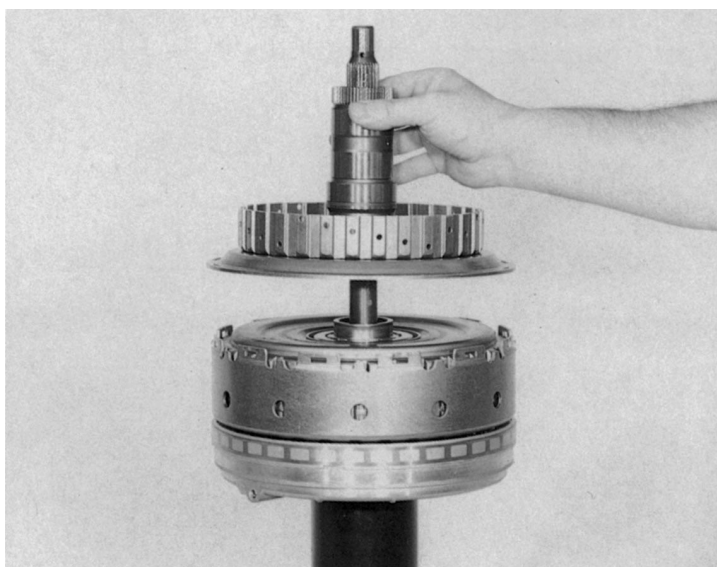

92 046

Remove axial needle bearing from cylinder B.

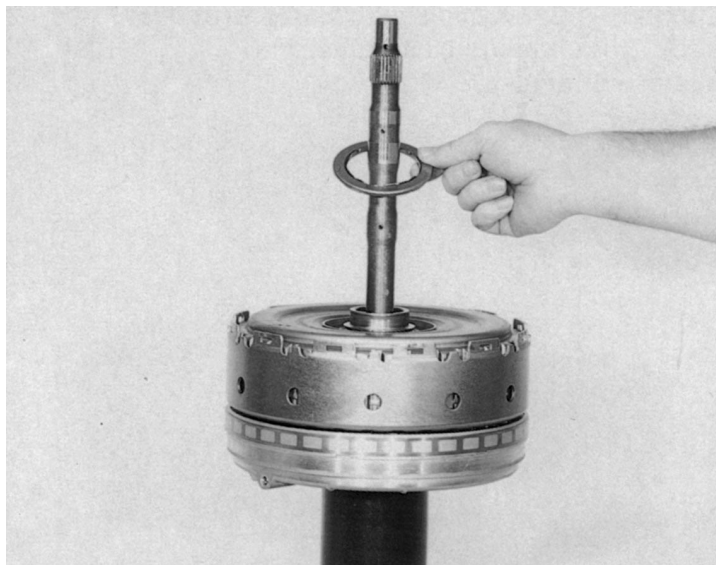

92 047

Lift clutch B off intermediate shaft.

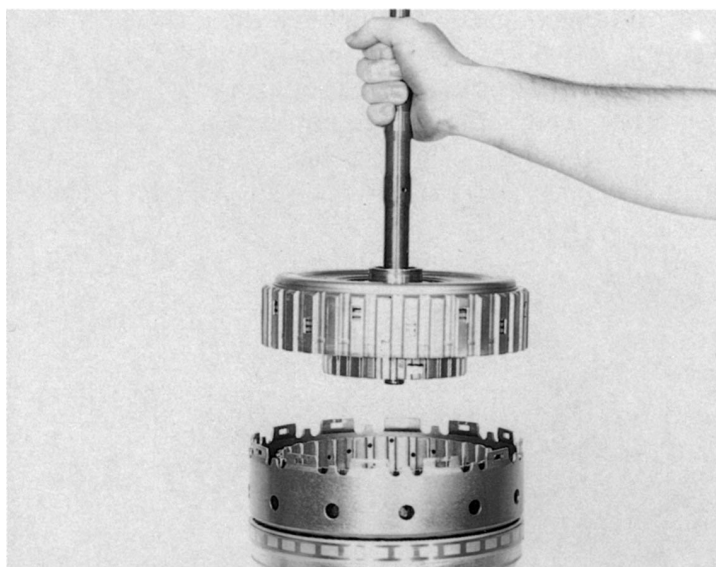

92 048

Lift intermediate shaft out of clutch B and remove angled disc with axial needle cage.

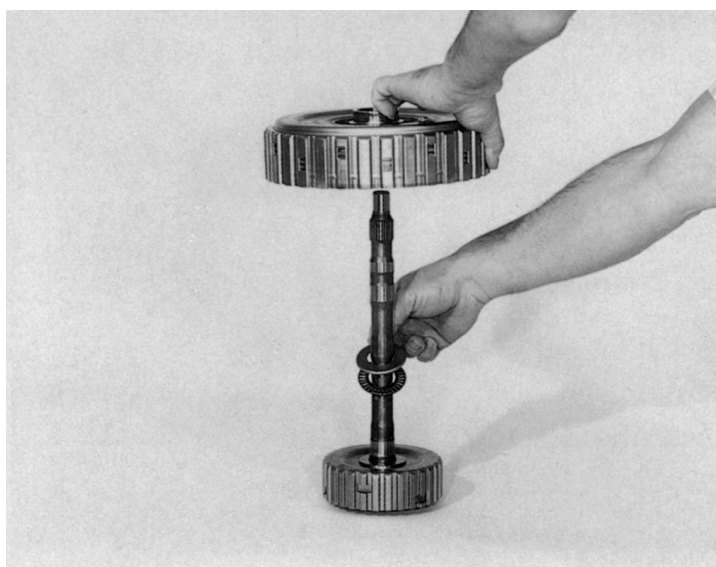

92 049

Extract snap ring from clutch B and remove complete disc pack.

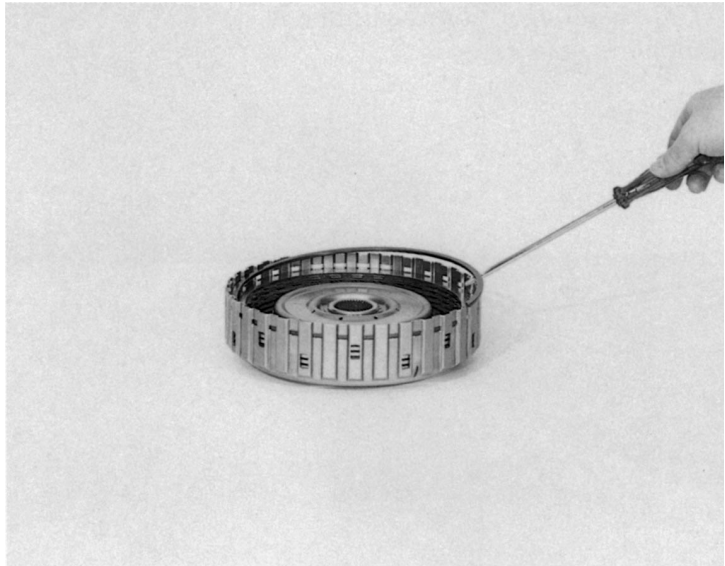

92 050

Use assembly bracket 5 X 46 000 928 to press oil dam down under mandrel press and remove snap ring using suitable pliers.

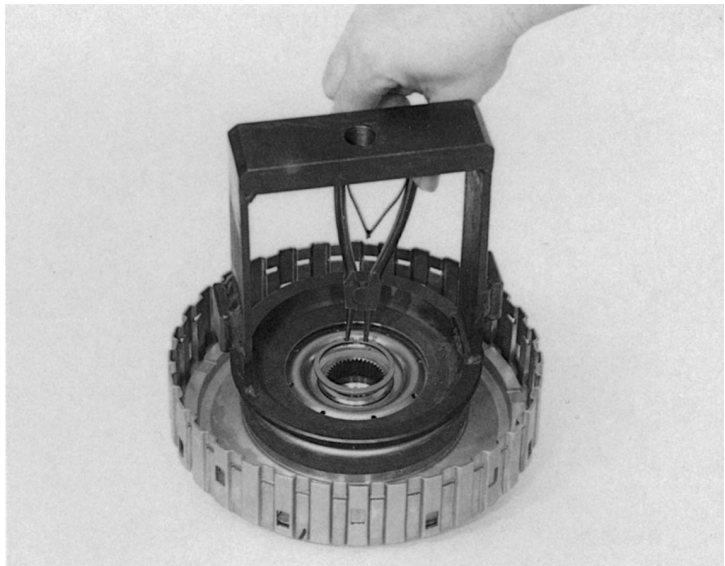

92 051

Remove oil dam and plate spring.

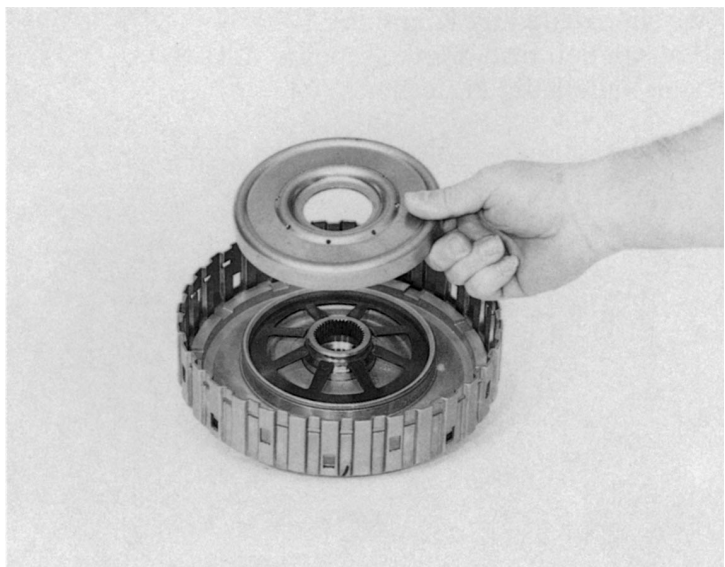

92 052

Apply compressed air jet to oil supply bore to press out piston B. Remove 3 O-rings from piston B.



92 053

Lift axial needle cage and angled disc from cylinder C.

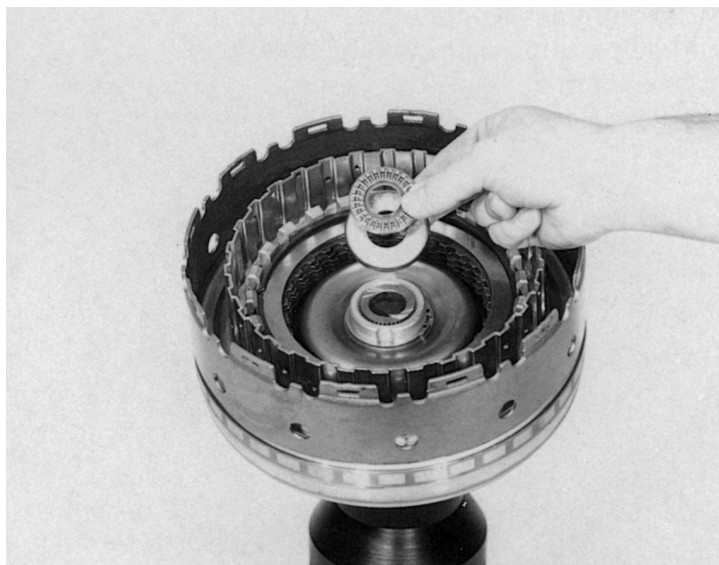

92 054

Extract snap ring from clutch A and lift out end disc A, inner disc carrier B and disc carrier C.

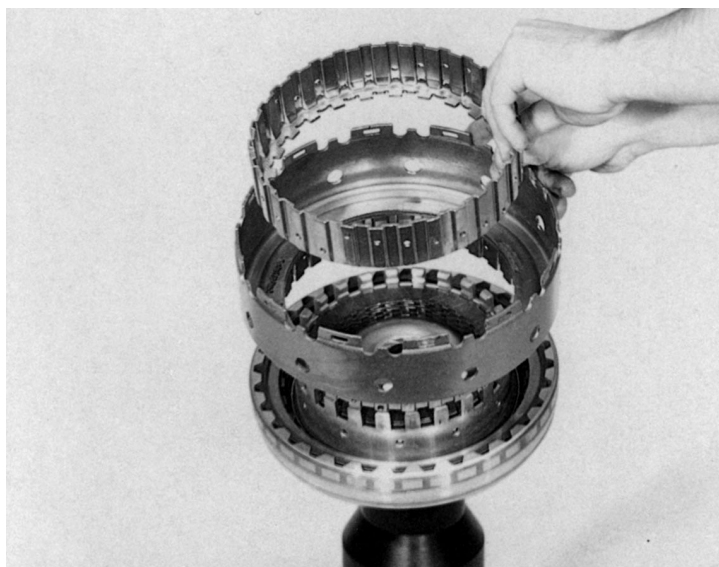

92 055

Remove complete disc pack from clutch A.

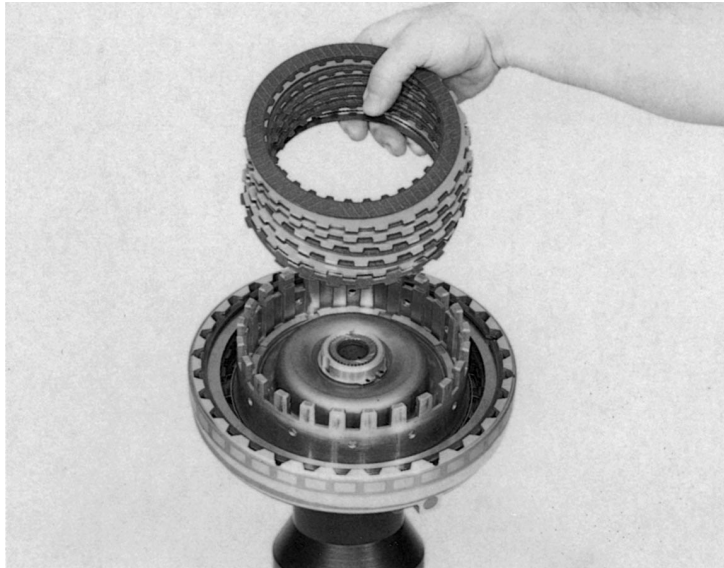

92 056

Extract snap ring from clutch C and remove complete disc pack C.

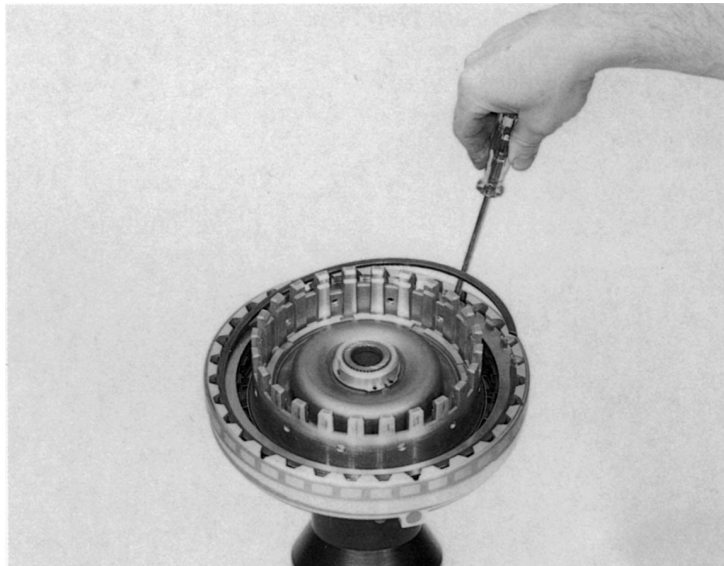

92 057

Press input shaft out of cylinders A + C. Slide O-ring and 2 rectangular-section rings off input shaft.

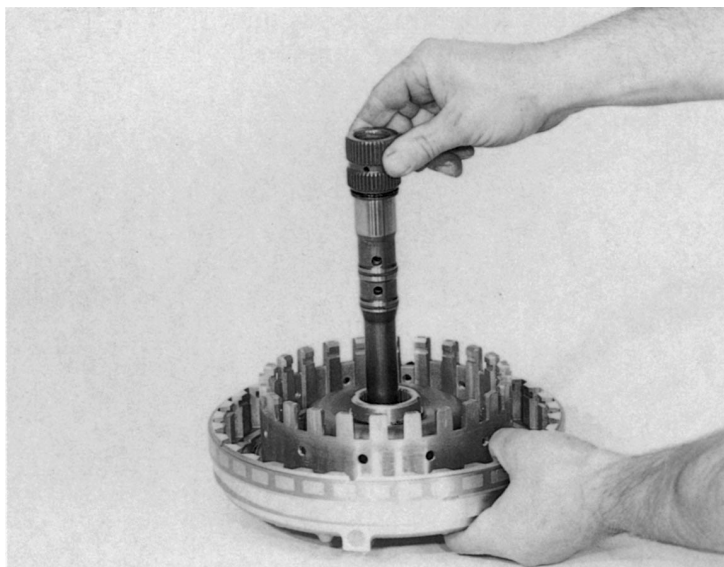

Use assembly bracket 5 X 46 000 931 to press oil dam of clutch A down under mandrel press and remove retaining ring using suitable pliers. Remove O-ring from oil dam.

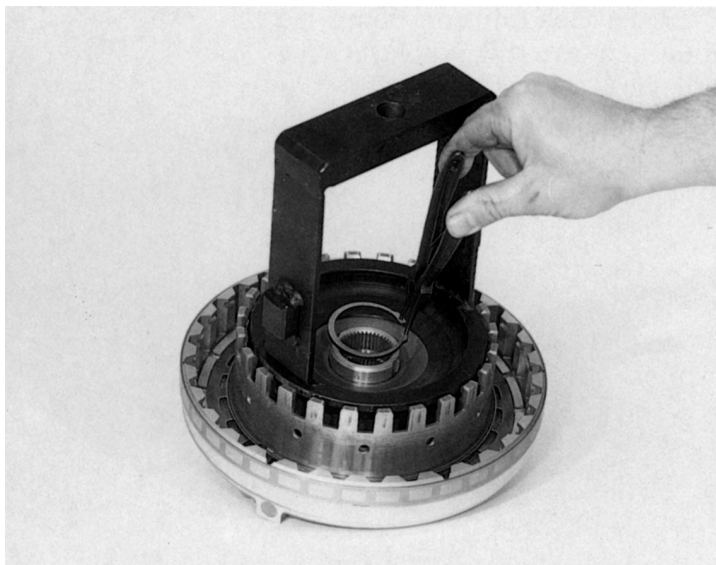

Cover one of the two oil supply bores and press out piston A using compressed air jet.

Remove both O-rings.

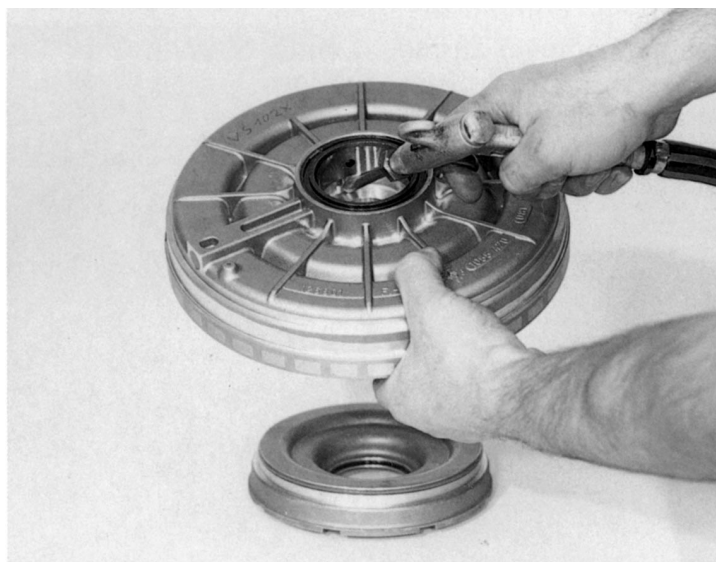

Use assembly bracket 5 X 46 000 064 to press down plate spring C under mandrel press, press down retaining ring and extract snap ring using a suitable screwdriver. Remove retaining ring and plate spring.

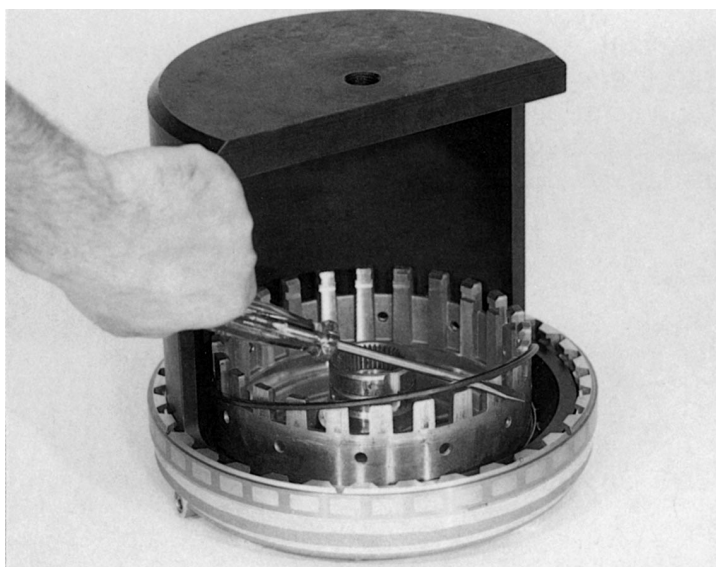

92 061

Cover two of the oil supply bores and blow out piston C using compressed air jet.
Remove both O-rings.

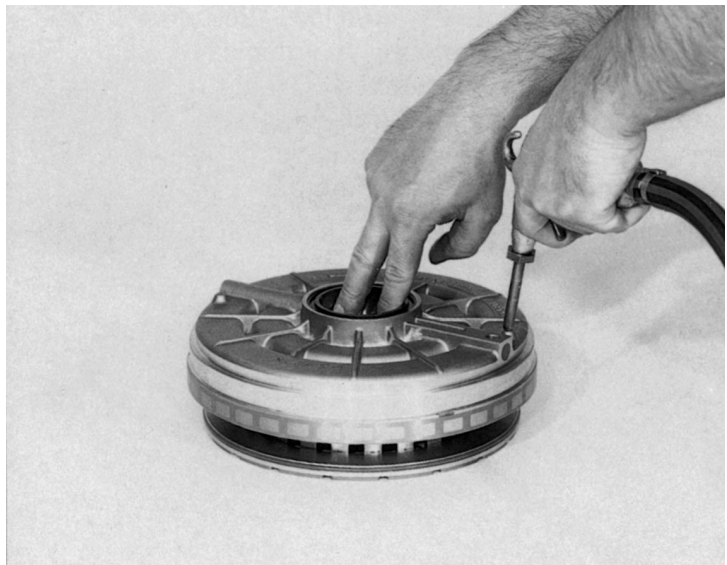

92 062

Extract snap ring with a suitable screwdriver and drive out bush using a plastic drift and a suitable baseplate.
Remove both O-rings.

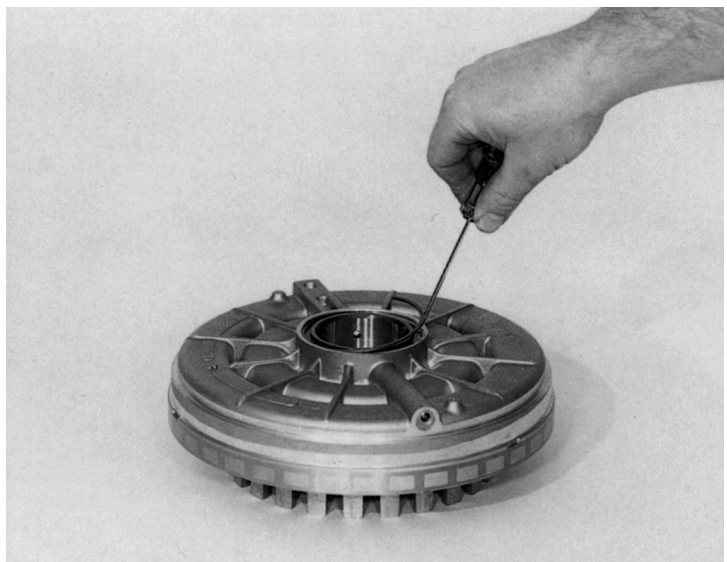

92 063

2.6 Oil supply

Place complete oil supply unit on a suitable baseplate.
Slide O-ring off centering plate and 2 rectangular section rings from the stator shaft.

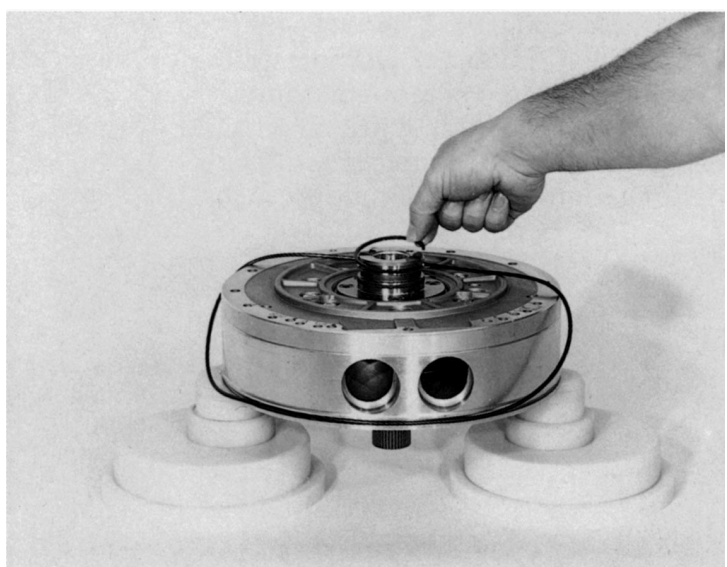

92 064

Remove 10 machine screws. Do not completely remove 2 opposing machine screws. Drive pump off along these screws by striking with plastic mallet.

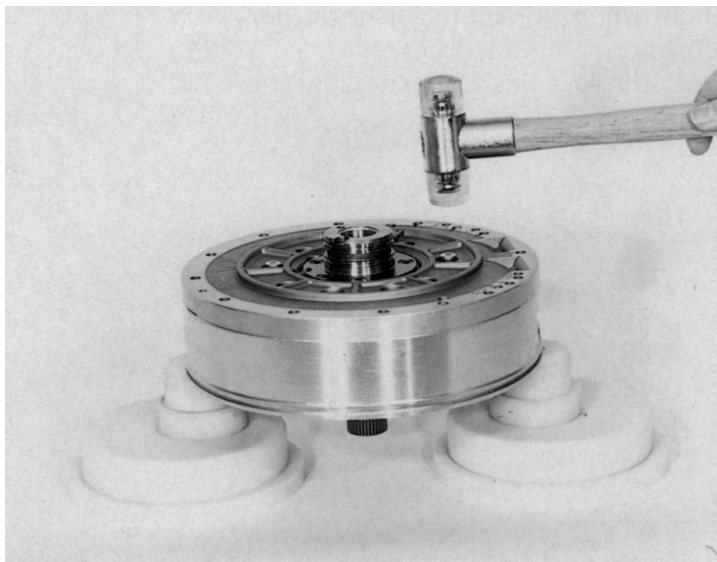

92 065

Remove O-ring. The pump can be dismantled by removing the impeller and ring gear. Extract sleeve (locating dowel).

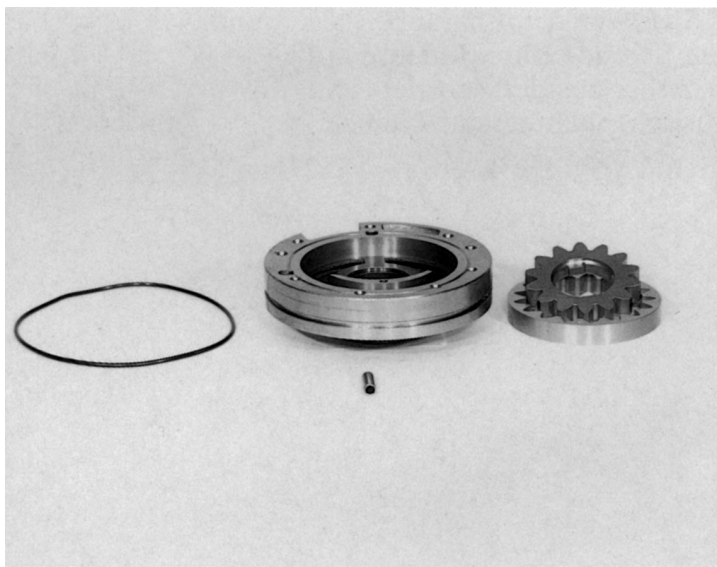

92 066

Extract snap ring and lever out shaft seat using suitable screwdriver. Remove corrugated disc.



92 067

Press out sealing ring and needle bearing under mandrel press. Diameter of pressure pin approx. 42 mm.

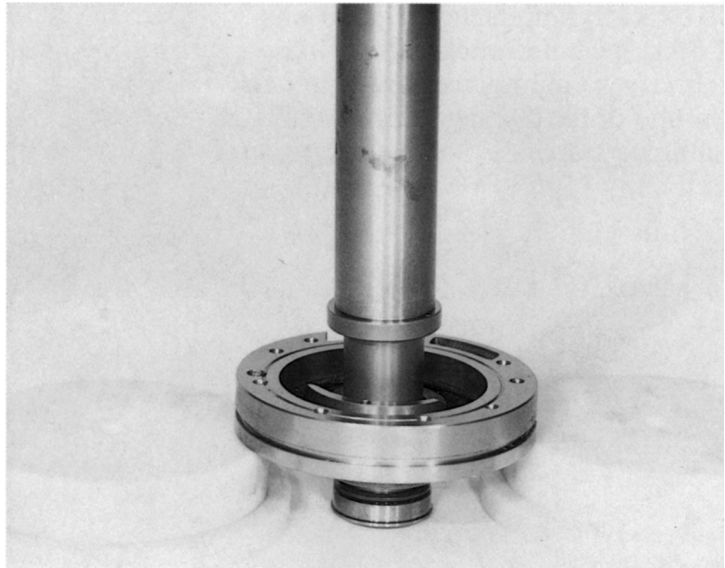

92 068

Remove 5 cheesehead screws and drive stator shaft out of centering and intermediate plates by striking with plastic mallet.

(Wrench size = Torx - TX 27)

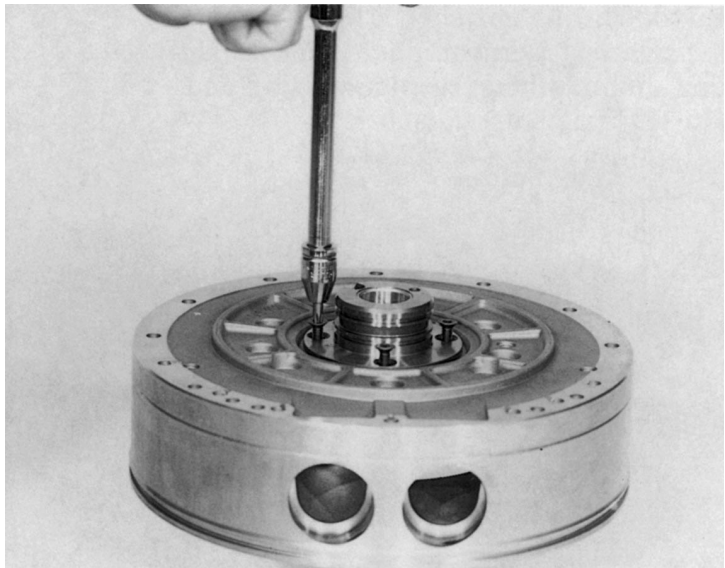

92 069

2.7 Housing with shaft unit and parking interlock

Use a suitable drift to drive the clamping sleeve out of the detent disc and extract the selector shaft.

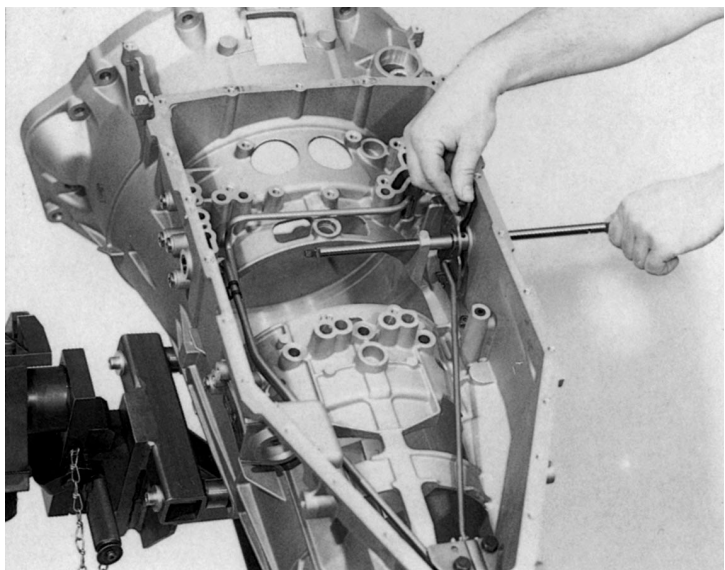

92 070

It is now possible to remove the detent disc with connecting rod and pipe.
Lever out both shaft seals using a screwdriver.

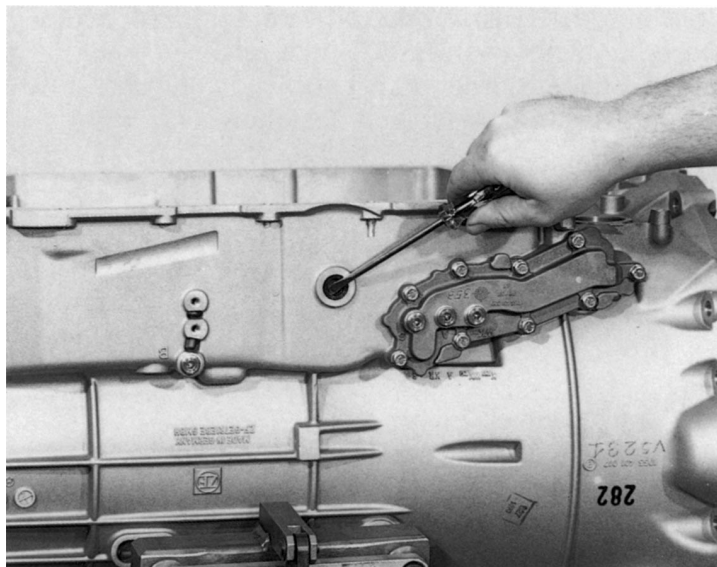

92 071

Normally, the detent spring remains in the transmission housing.
If this has to be dismantled, unscrew both machine screws.

Caution!

On old versions, the locating pin is loose.

(Wrench size = Torx - TX 27)

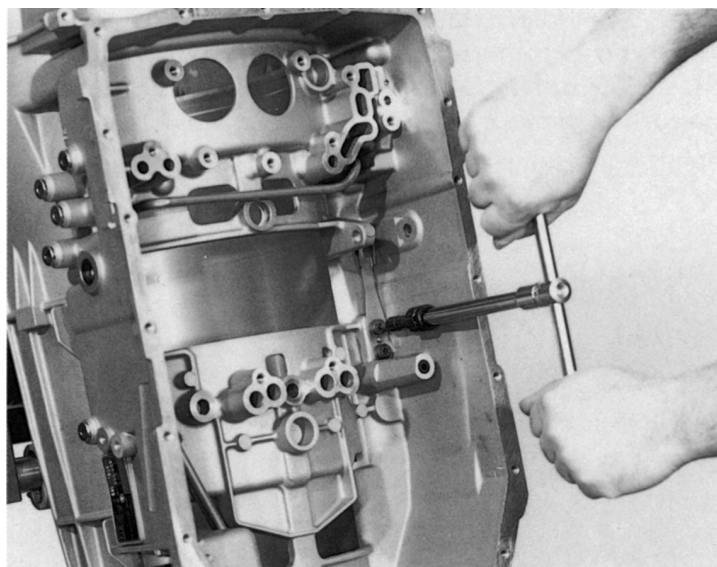

92 072

Unscrew both hex screws and remove guide plate.

(Wrench size = 13 mm across flats)

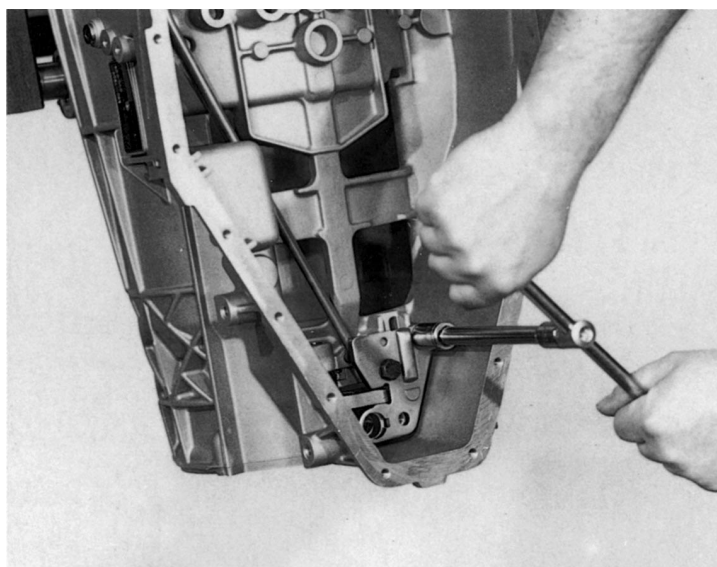

92 073

Press pin out of transmission interior using drift and remove pawl and leg spring.

Remove O-ring from pin.

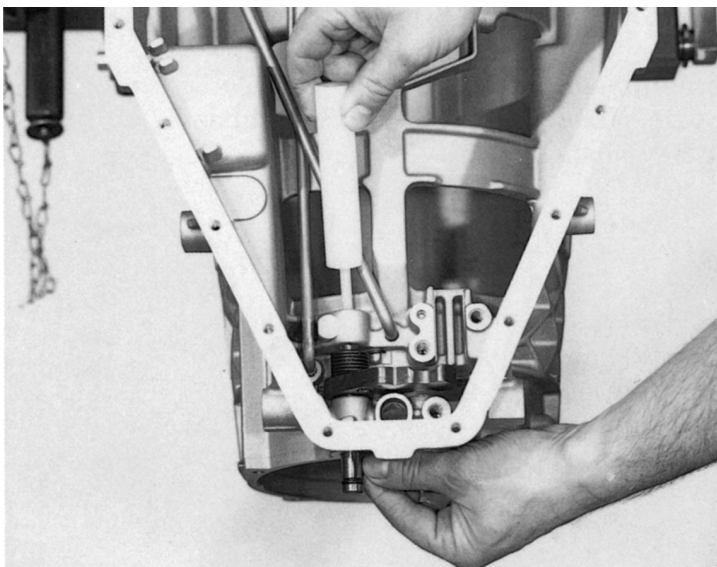

92 074

Renewal of the pipe and oil pipe is always recommended. To do this, unfasten machine screw and remove bracket.

(Wrench size = Torx - TX 27)

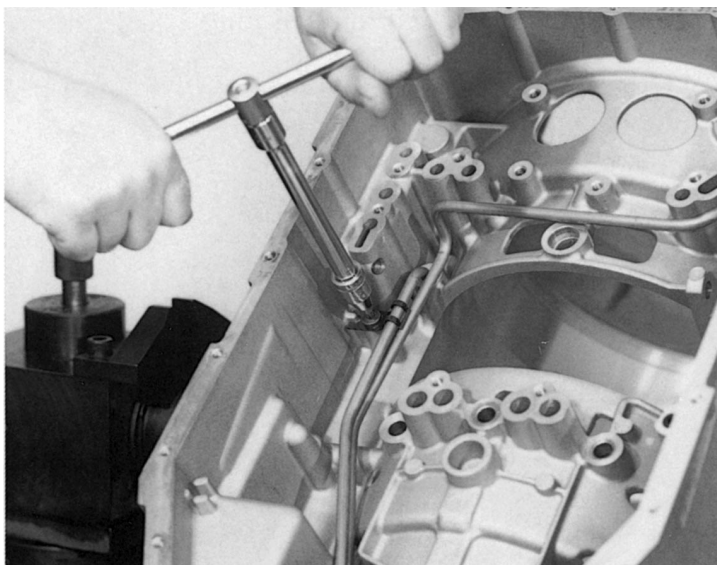

92 075

To clean the transmission housing, it is advisable to take out all the sealing screws.

(Wrench size - Allen key insert = 5 mm)

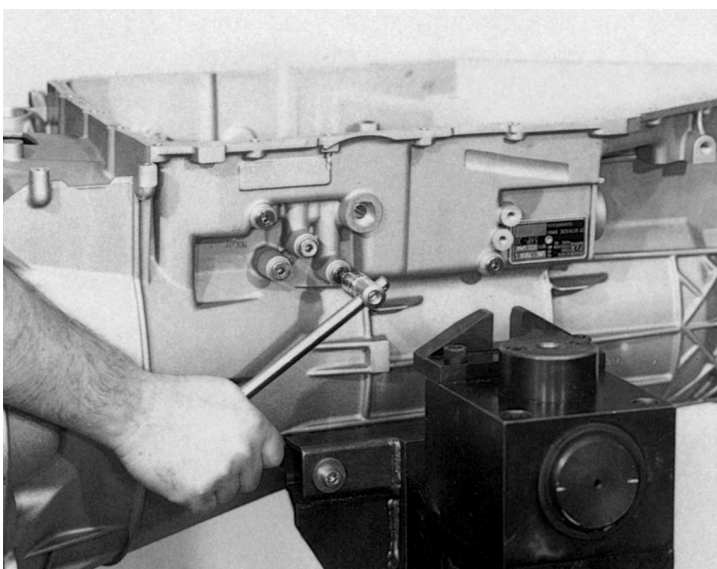

Unscrew 9 hex screws and remove cover and gasket.

(Wrench size = 10 mm across flats)

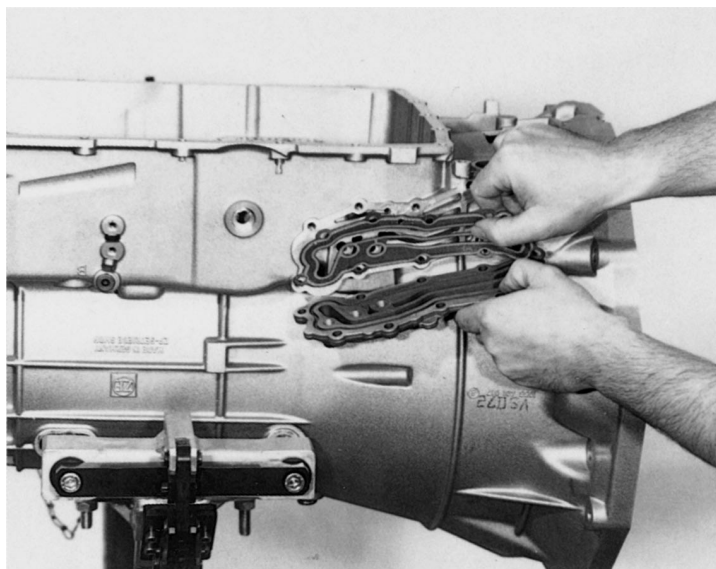

3. Assembly

3.1 Housing with shift assembly and parking detent

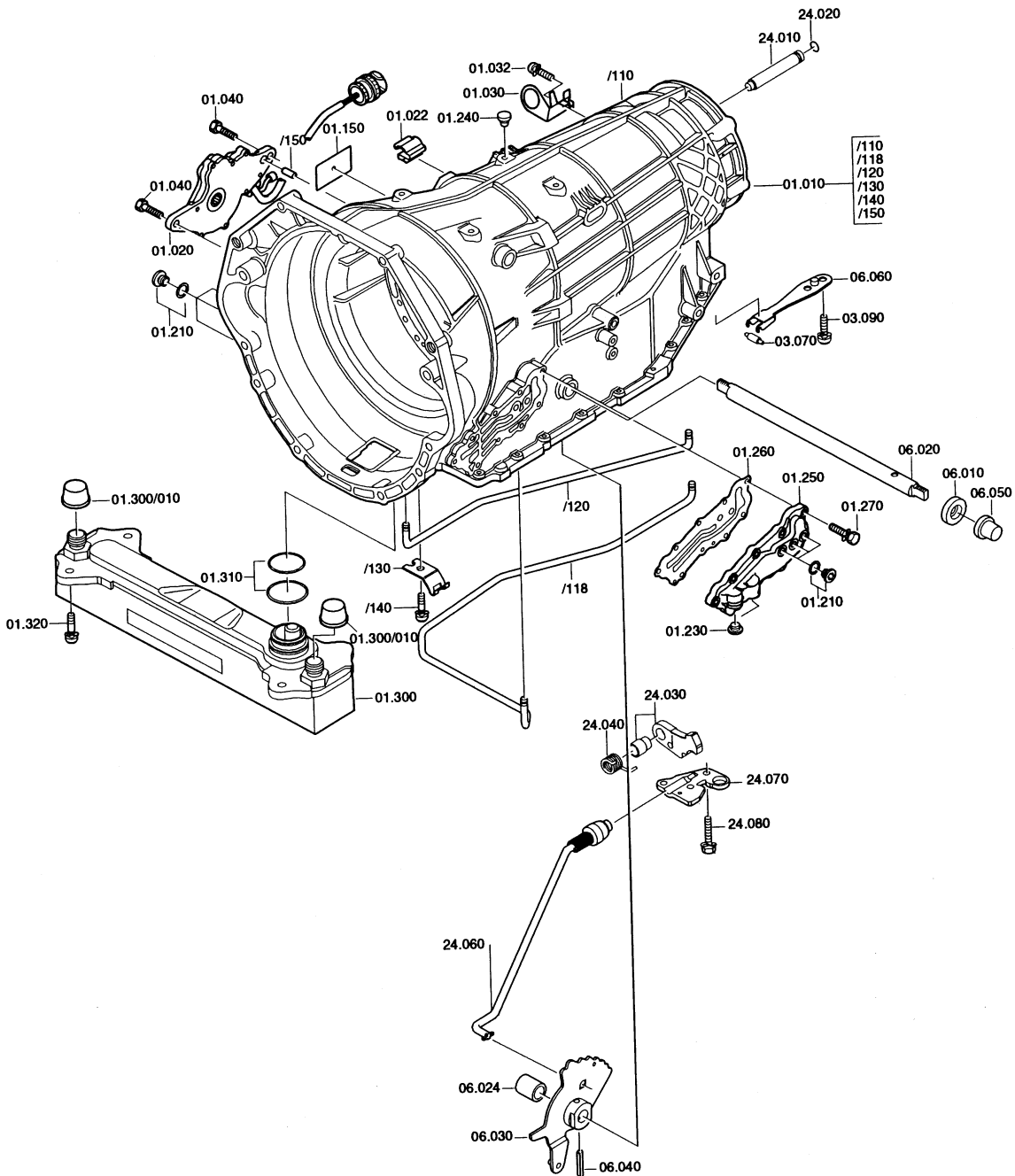

92 077

If necessary, replace vent 01.240.
Drive new pipe 01.010/118 into transmission housing 01.010/110, using locating aids 5 X 46 000 846 and 5 X 46 000 853.

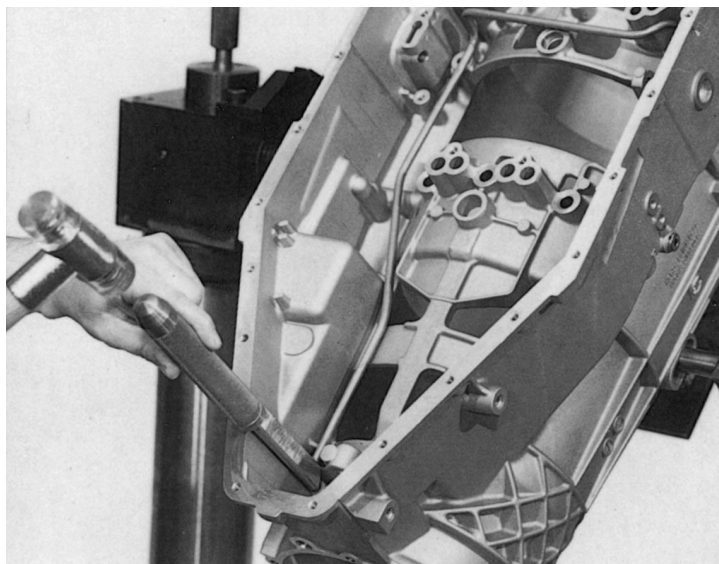

92 078

Drive new oil pipe 01.010/120 into place with locating aid 5 X 46 000 846 and secure with bracket 01.010/130 and machine screw 01.010/140.

(Wrench size = Torx - TX 27)
(Tightening torque = 10 Nm)

It is recommended to clean pipe and oil pipe with a jet of compressed air.

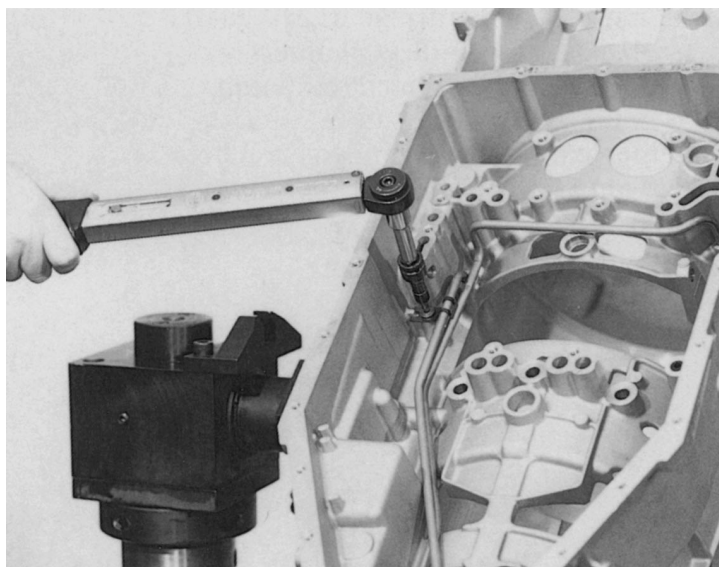

92 079

Coat new gasket 01.260 with grease (Vaseline) and align.
Secure cover 01.250 to housing with 9 hex screws 01.270.

(Wrench size = 10 mm across flats)
(Tightening torque = 8 Nm)



92 080

Screw a total of 6 screw plugs 01.210 into transmission housing or cover, each with new seals attached.

(Wrench size = 5 mm Allen screw)
(Tightening torque = 15 Nm)

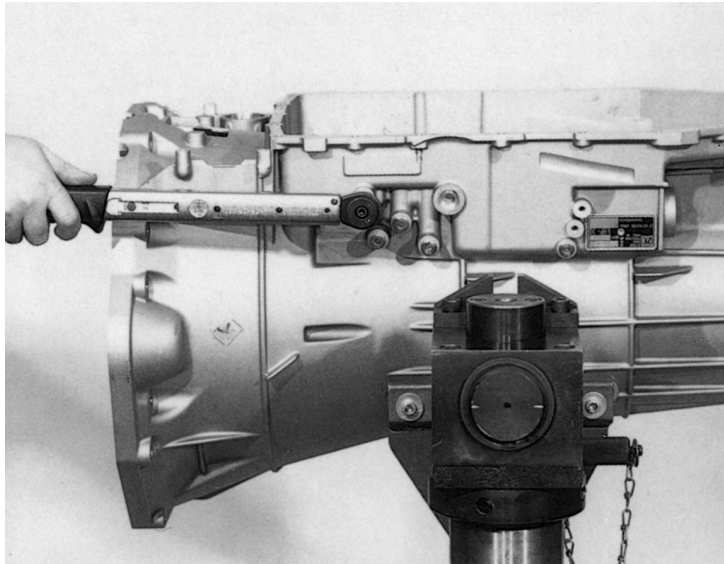

92 081

Fit two new O-rings 01.310 to the oil filler plugs on oil cooler 01.300 and apply light coating of grease (Vaseline). Secure oil cooler to transmission housing with 4 machine screws 01.320.

(Wrench size = Torx TX 27)
(Tightening torque = 8 Nm)

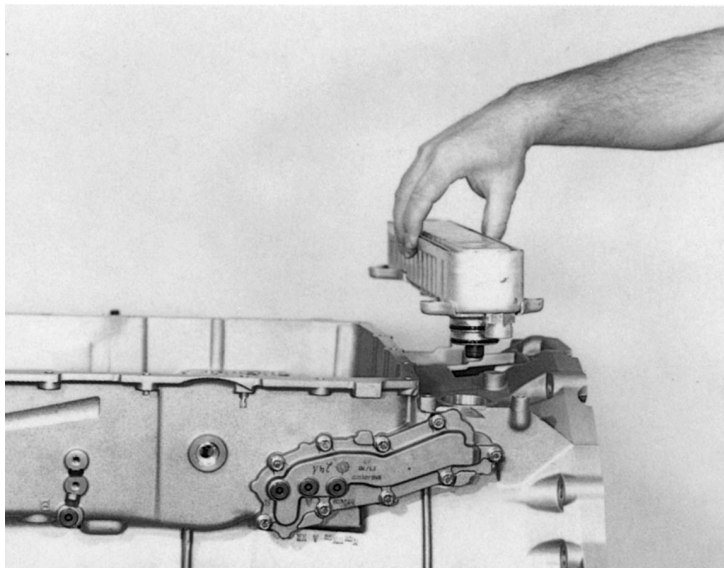

92 082

Drive two new shaft seals 06.010 into each side of the transmission housing using a press-in drift 5 X 46 000 737.

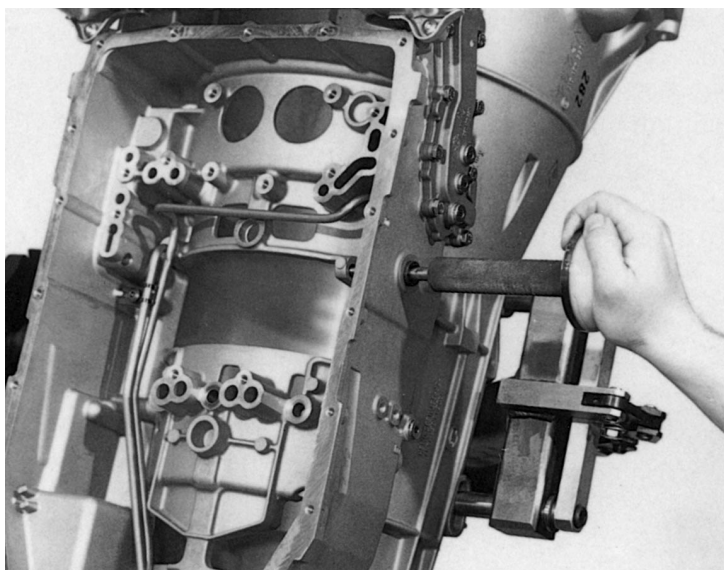

91 069

Use plastic mallet to drive roller 06.070 into detent spring 06.060.

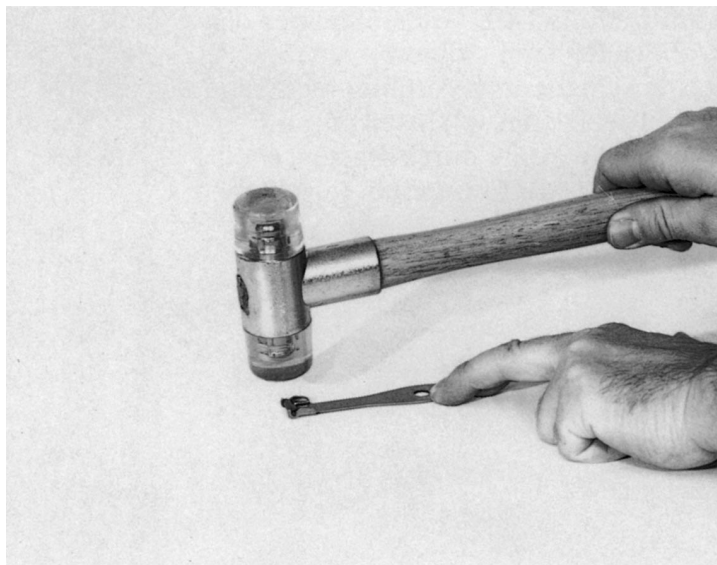

92 083

Loosely secure detent spring with 2 machine screws 06.090 to allow the detent springs to slide more easily. In older versions, fit the locating pin separately.

(Wrench size = Torx - TX 27)

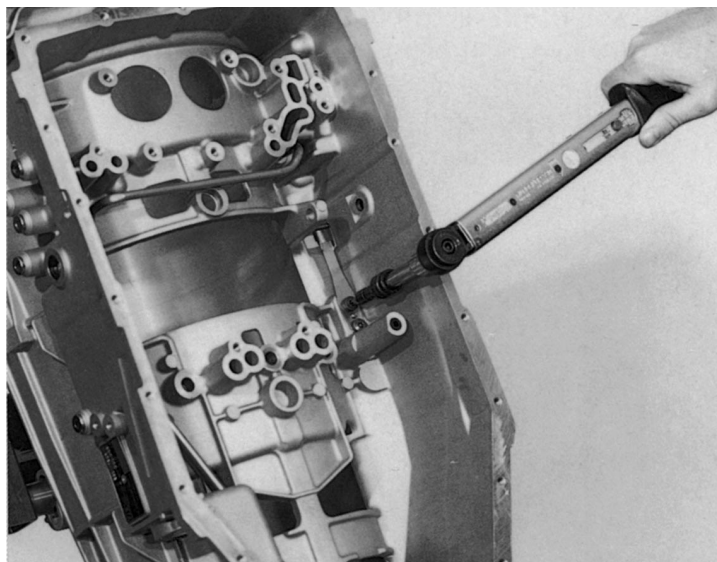

91 071

Locate connecting rod 24.060 in detent disc 06.030 and rotate to secure.

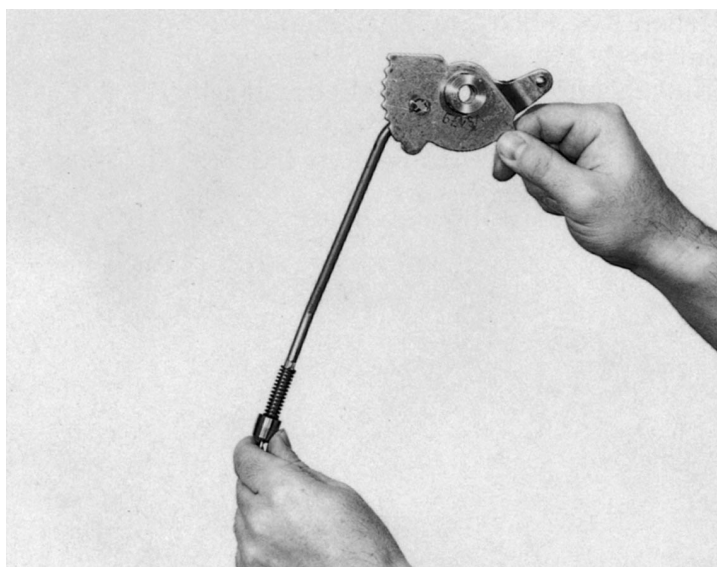

92 084

Fit assembly sleeve 5 X 46 000 688 over end of the selector shaft. Insert detent disc in transmission housing together with connecting rod and slide selector shaft 06.020 through detent disc and pipe 06.024.

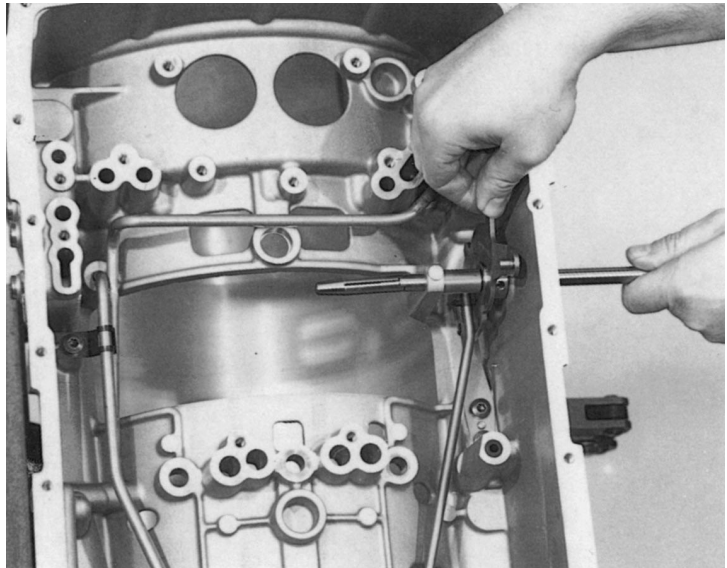

92 085

Drive new clamping pin 06.040 into position using punch 5 X 46 000 944 or a suitable drift until the flattened area on the end of the selector shaft spline points towards the output end.

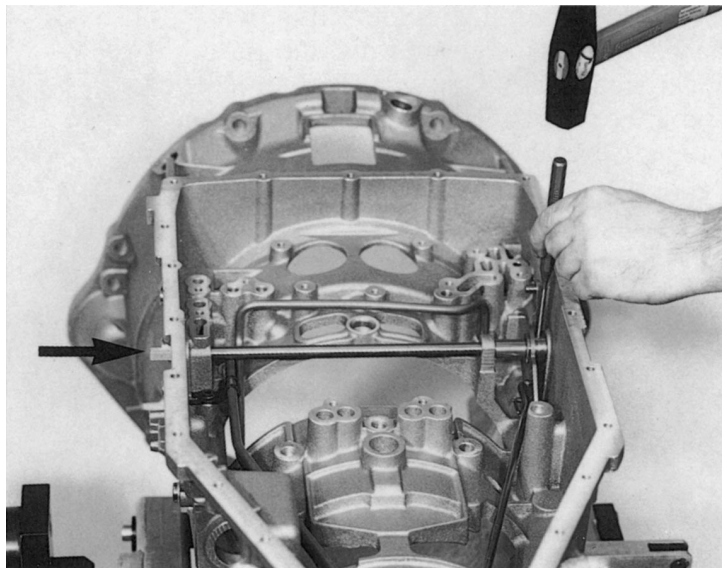

92 086

Fit new O-ring 24.020 to pin 24.010
Insert pawl 24.030 with leg spring 24 040 in transmission housing and locate by pressing down on the pin.

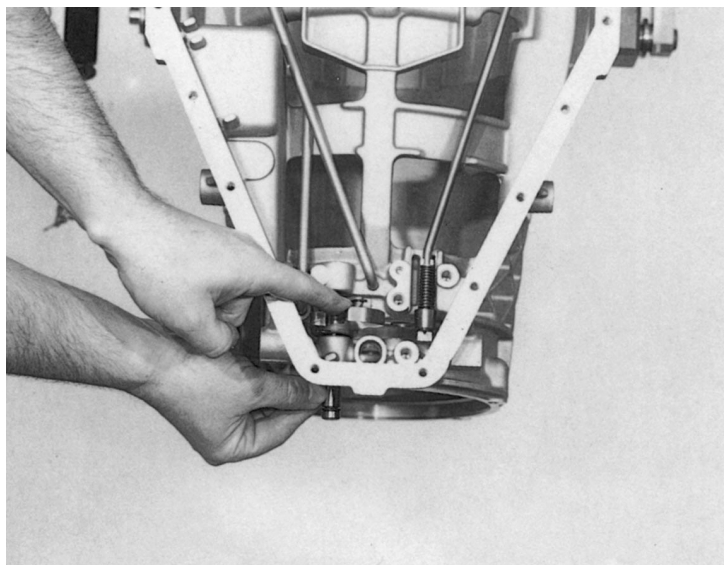

Press down pawl: connecting rod must be pressed backwards by rotating the detent disc, and guide plate 24.070 must initially be secured by 2 hex screws 24.080.

(Width across flats = 13 mm)
(Tightening torque = 23 Nm)

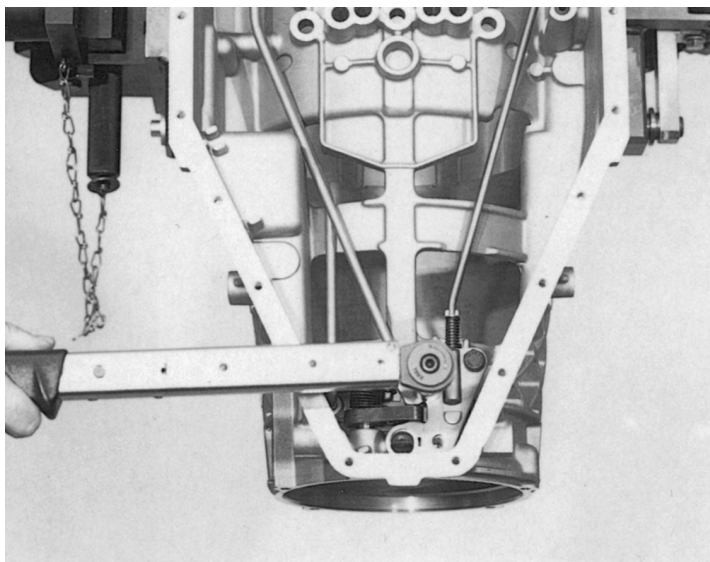

Caution!

If the transmission housing, detent spring, detent disc or selector shaft were replaced, or if the detent springs were unfastened, the switch (detent spring) must be reset. (see Pt. 1.4.10, Page 5/11).

Drive dowel pin 01.060 into transmission housing with plastic mallet until it protrudes by no more than 5.0 - 5.5 mm.



Fit switch 01.020 to selector shaft and secure with 2 hex screws on transmission housing.

(Width across flats = 10 mm)
(Tightening torque = 8 Nm)

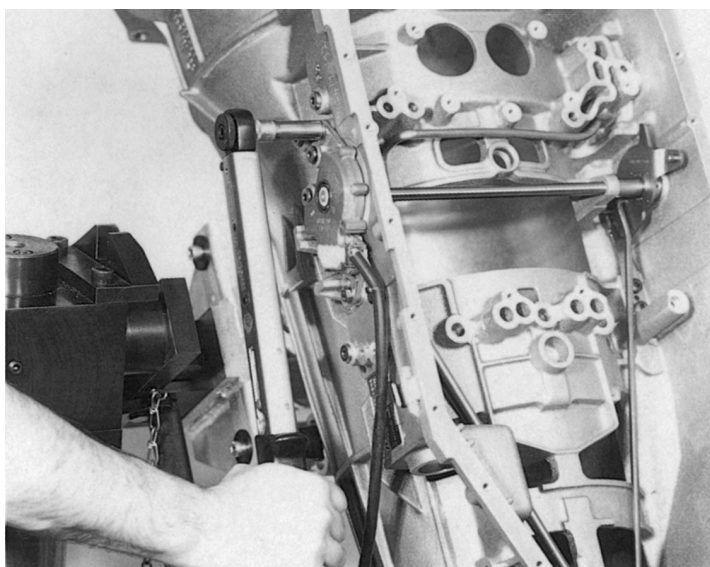

Attach cable clip 01.022 and secure the cable with it. Secure cable plug with bracket 01.030 using machine screw 01.032.

(Wrench size = Torx - TX 27)
(Tightening torque = 8 Nm)

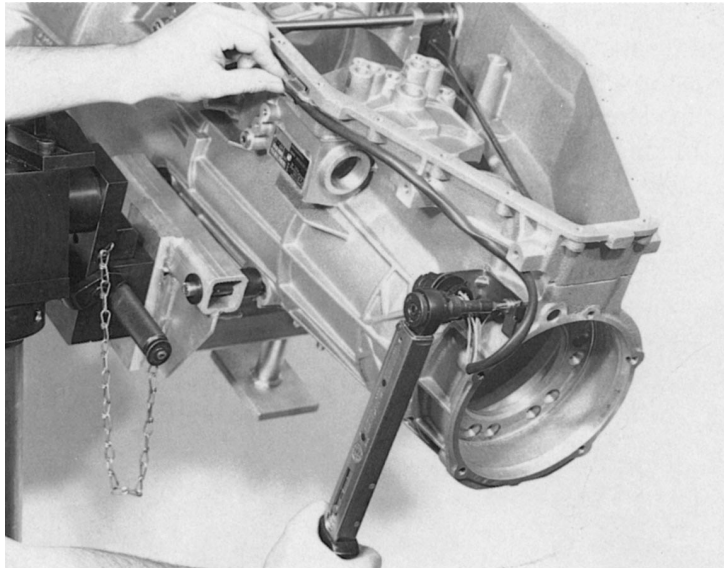

Inspect switch.
Check amperage of all pins on cable plug from P to 2 using tester.
(see Pt. 1.4.11, Page 5/12)

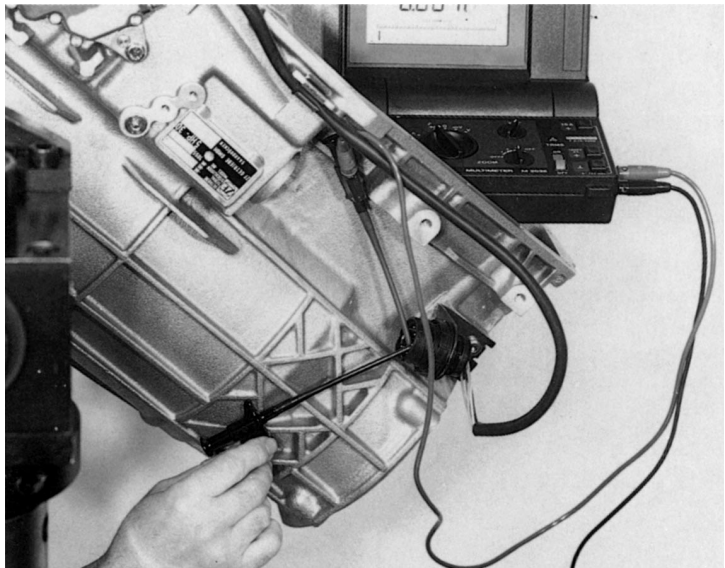

3.2 Brake F with freewheel unit for 1st gear

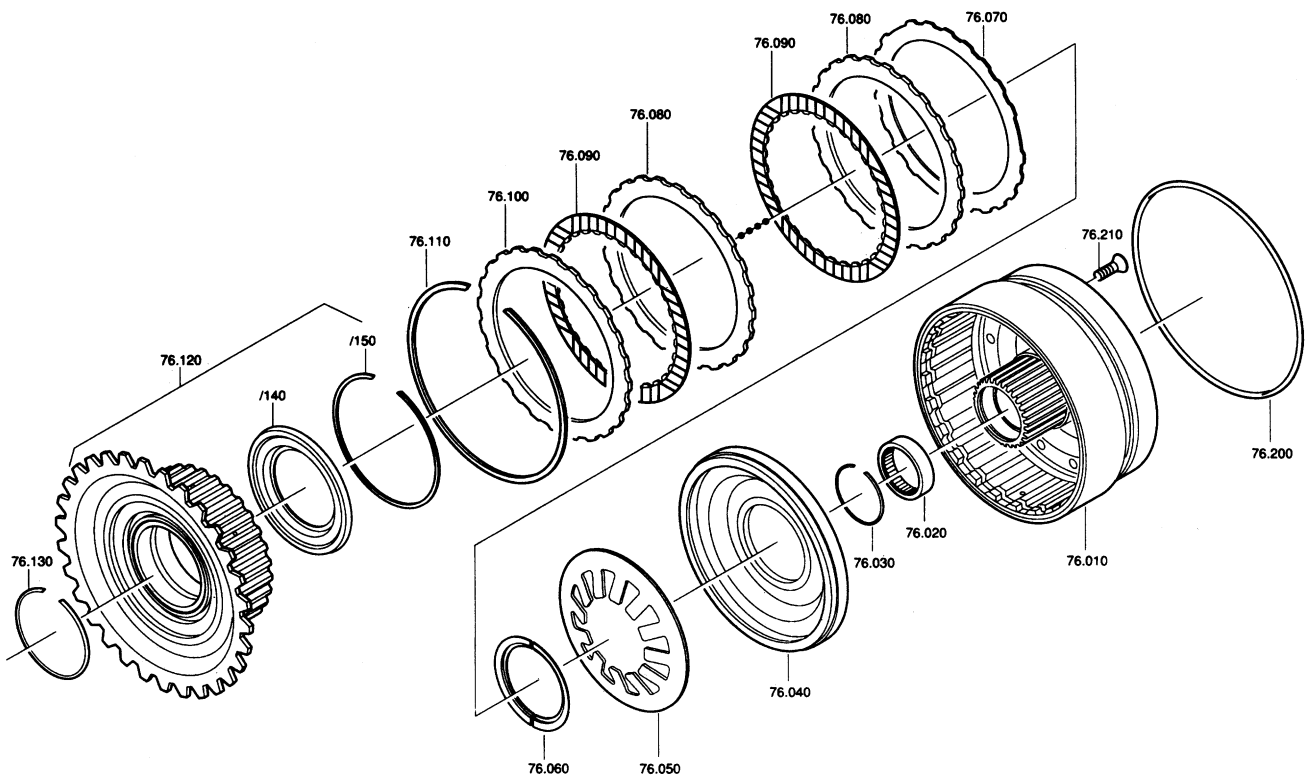

Fit O-ring 76.200 to cylinder F 76.010.
Press needle bearing 76.020 into
cylinder F with press-in fixture
5 X 46 001 006 under madrel press and
secure with snap ring 76.030.

92 088

Apply light coat of grease (Vaseline) to inner and outer sealing lips of piston F 76.040 and press into cylinder F.

Caution!

Piston must not be tilted, do not fold the sealing lips over.

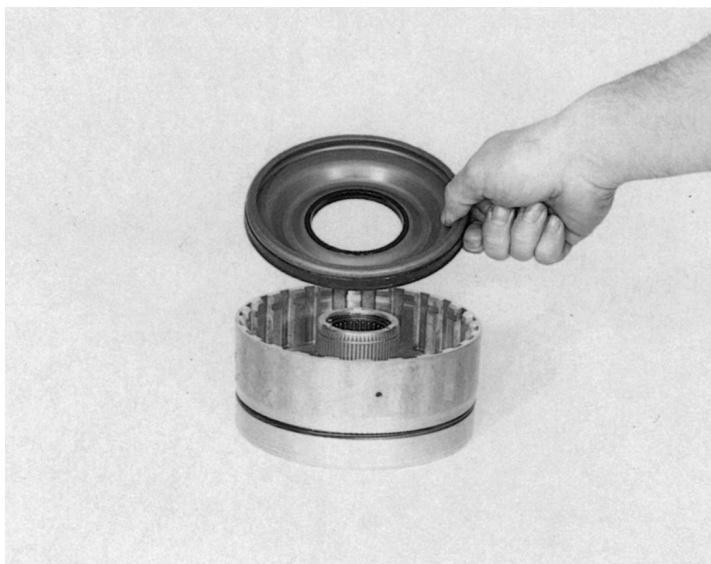

Insert plate spring 76.050 and press down under mandrel press with assembly bracket 5 X 46 000 931 and it split retaining ring 76.060.

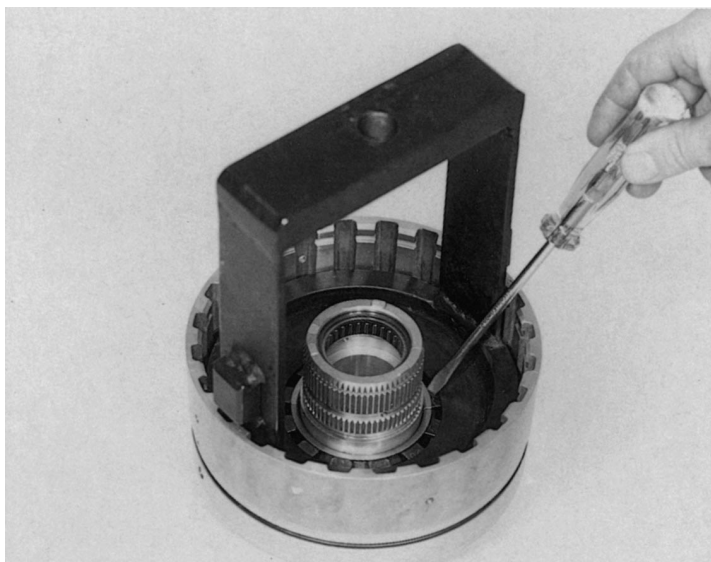

Install complete disc pack, starting with spring disc 76.070. Follow this with outer disc 76.080 and lined disc 76.090. Secure outer disc 76.100 with snap ring 76.110.

Caution!

Adjustment work (see Item 1.4.1, Page 5/1)

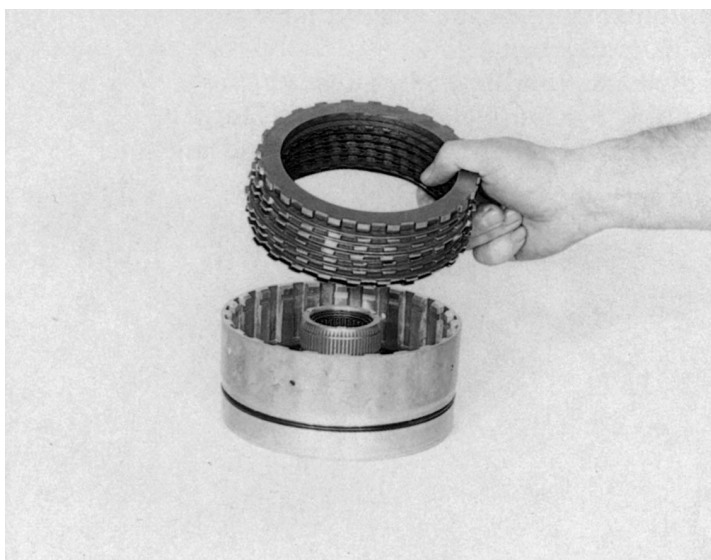

Finish assembly of freewheel on 1st gear 76.120 by first pressing one of the two washers on the freewheel unit into the freewheel race F.

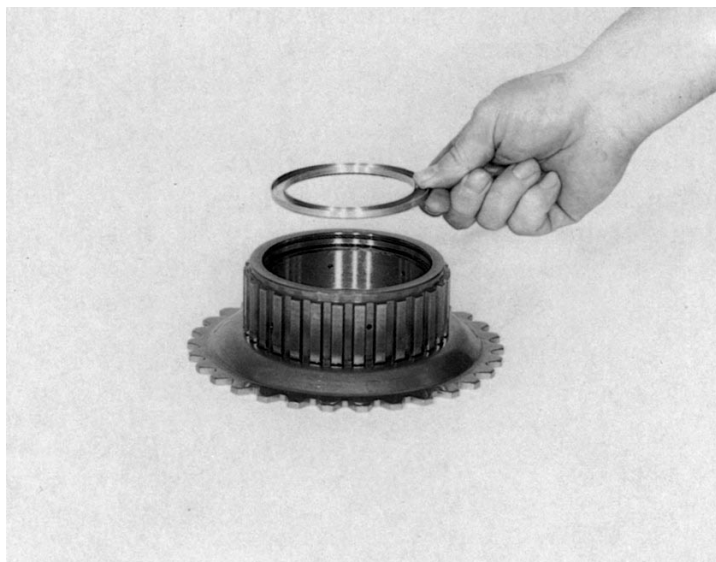

Install complete freewheel cage of freewheel unit with collar facing upwards.

Caution!

If fitted incorrectly (i.e. the wrong way round), the sprag function will not operate (wrong direction of rotation).

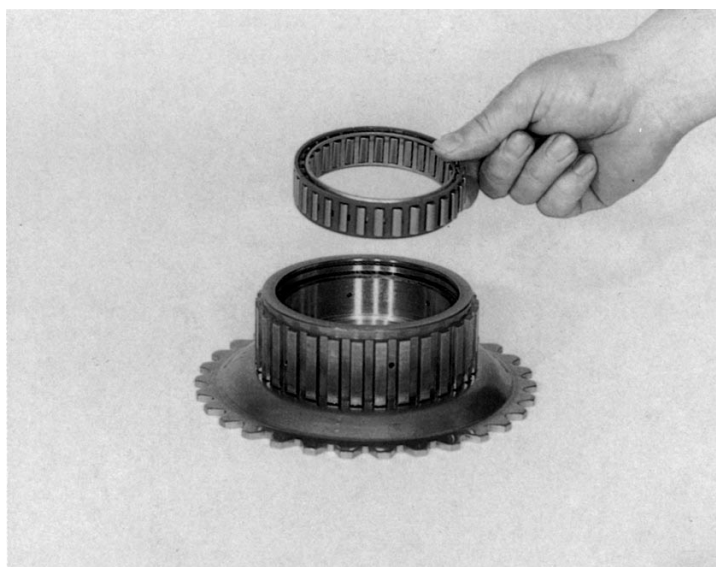

Fit washer on freewheel unit and press into place.

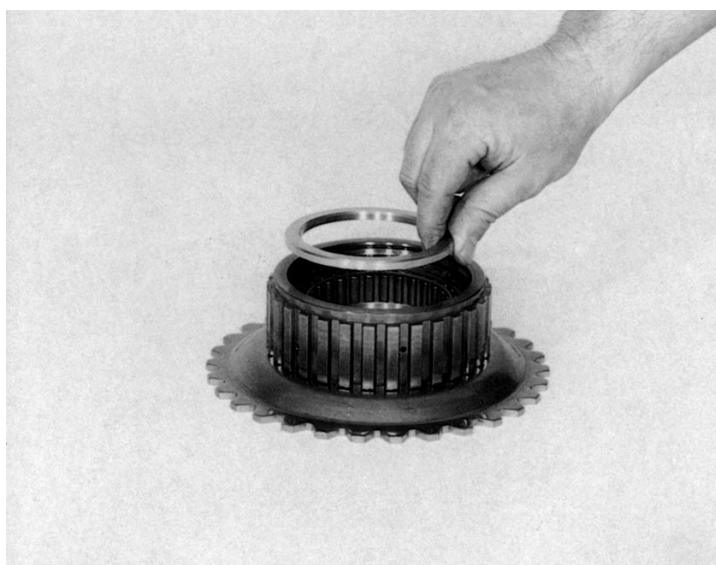

Insert inner race of freewheel by rotating clockwise.

Caution!

Function check:
Inner race of freewheel must rotate freely in clockwise direction when outer race is gripped firmly.

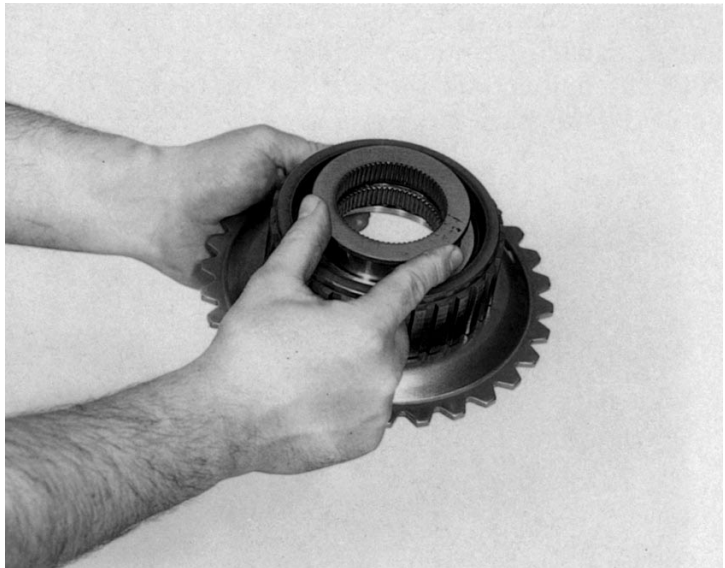

Press in retaining disc 76.120/140 and secure using snap ring 76.120/150.

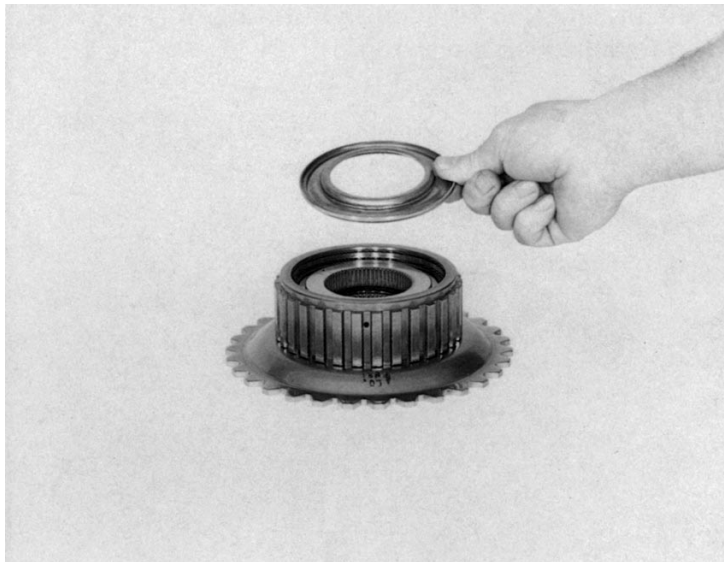

Install complete freewheel unit in brake, rotating it to do so. Now insert snap ring 76.130 with assembly tool 5 X 46 000 892 or by hand.

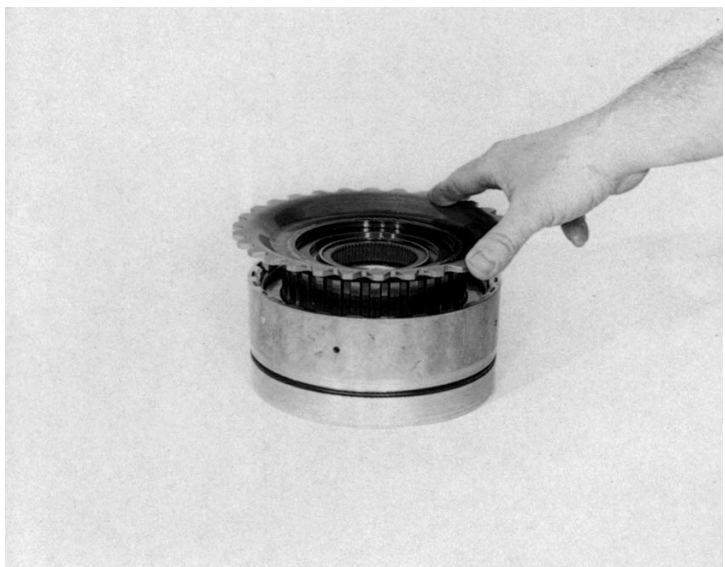

Insert lifter 5 X 46 000 831 in brake F in such a way that all three recesses in collar of lifter locate on the 3 protruding lugs of the cylinder hub.

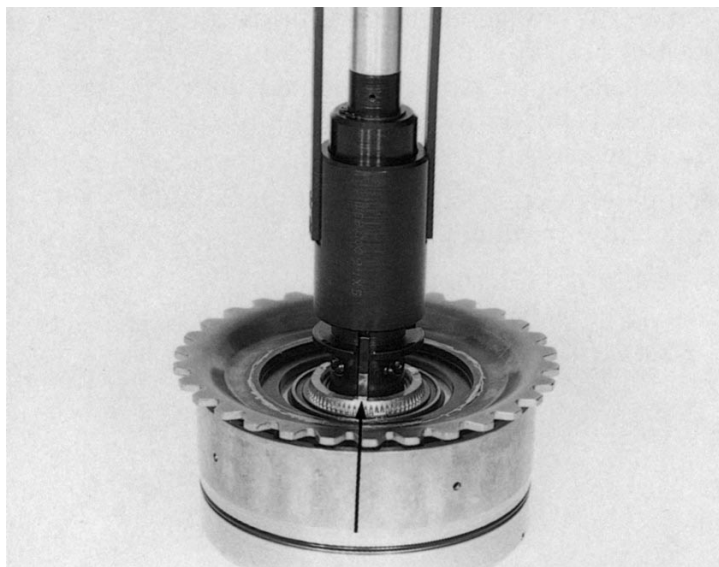

Rotate freewheel race F in such a way that the 3 aligned bores in cylinder F locate precisely between two teeth in freewheel race F. Mark these two teeth.

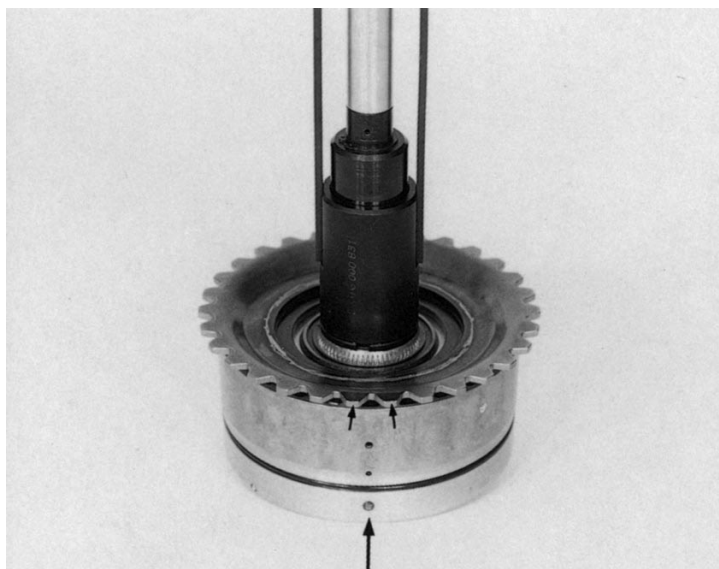

Rotate transmission housing through 90 degrees. Install the complete unit in such a way that the marked teeth always engage centrally under the web on the transmission housing.

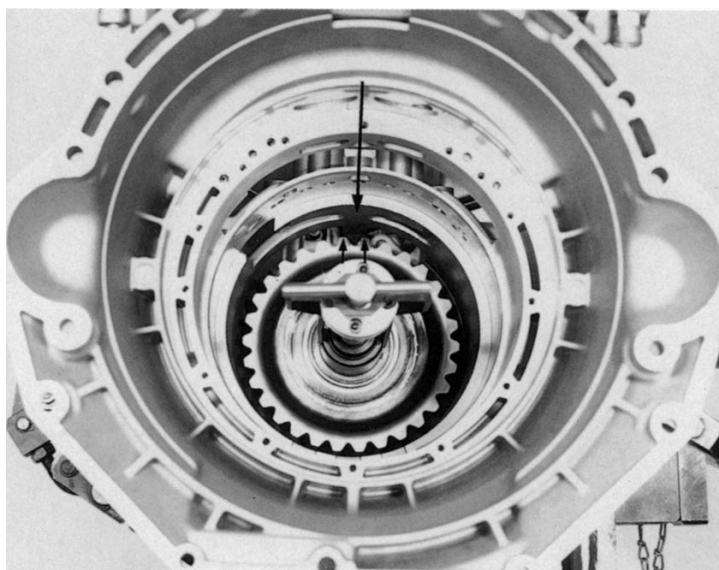

Place housing in horizontal position.
Align bores in cylinder F and transmission housing precisely and secure cylinder F with 12 countersunk screws 76.210.

(Wrench size = Torx - TX 40)
(Tightening torque = 23 Nm)

Remove the fixture.

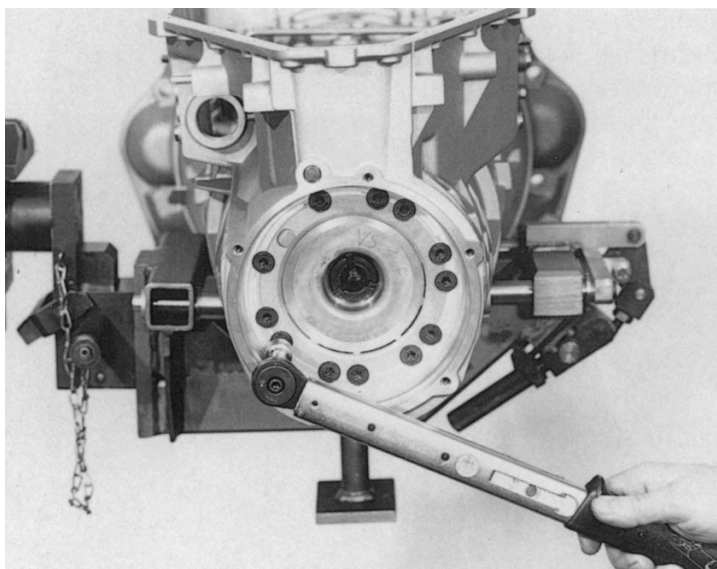

3.3 Tower I

3.3.1 Planetary drives (I,II and III)

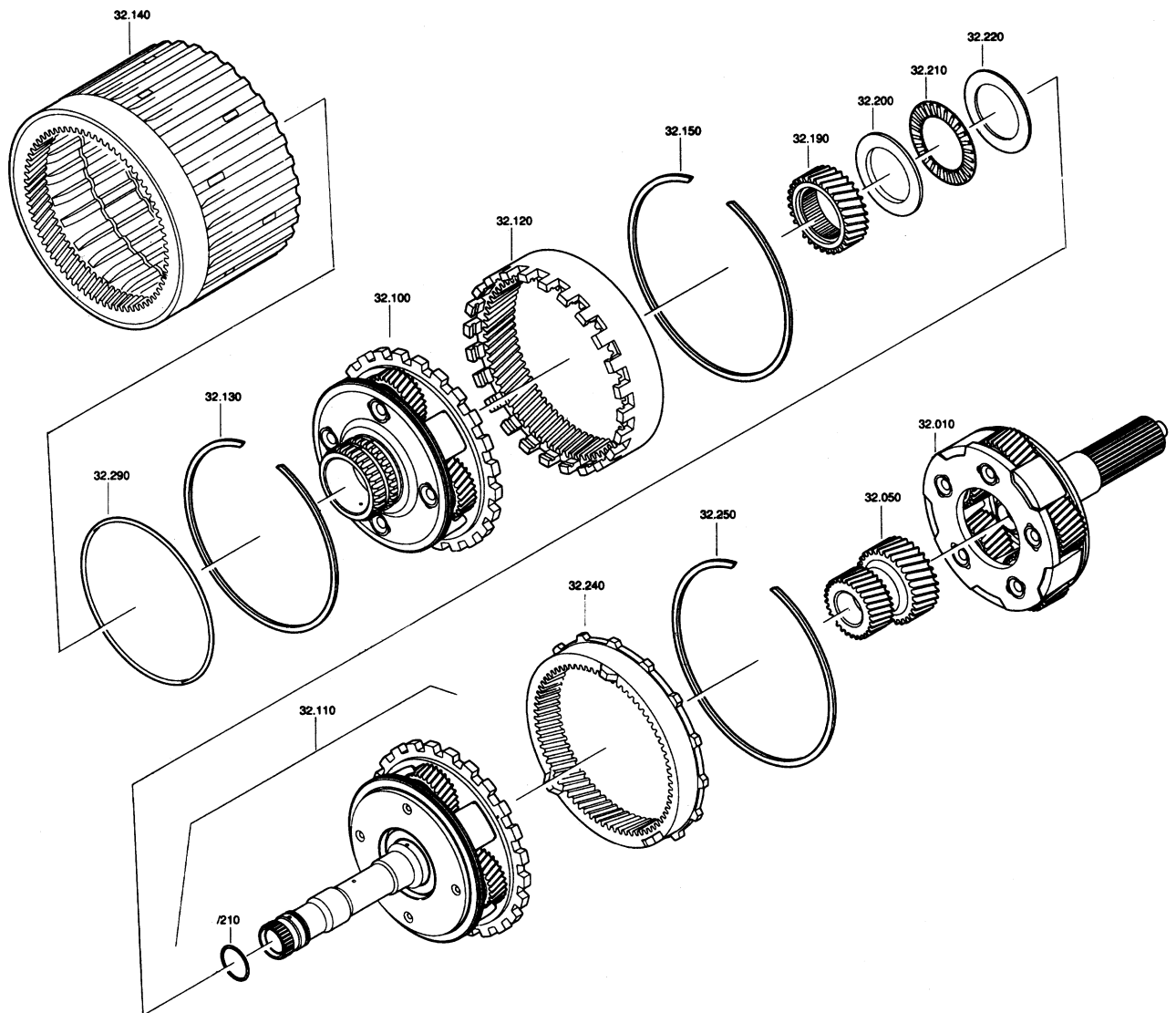

Fit new O-ring 32.290 to planet carrier I 32.100. Install planet carrier in ring gear II 32.120 and secure with snap ring 32.130.

92 105

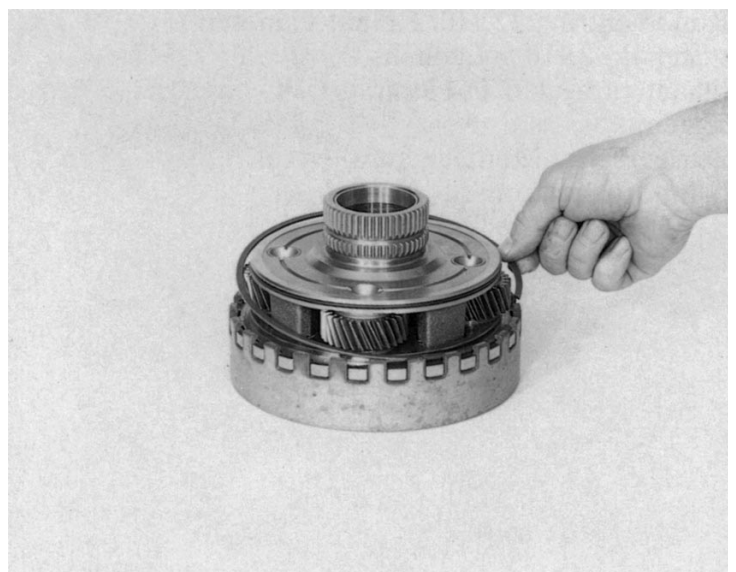

Insert complete unit in ring gear I 32.140 and install snap ring 32.150. For this, place ring gear on suitable base.

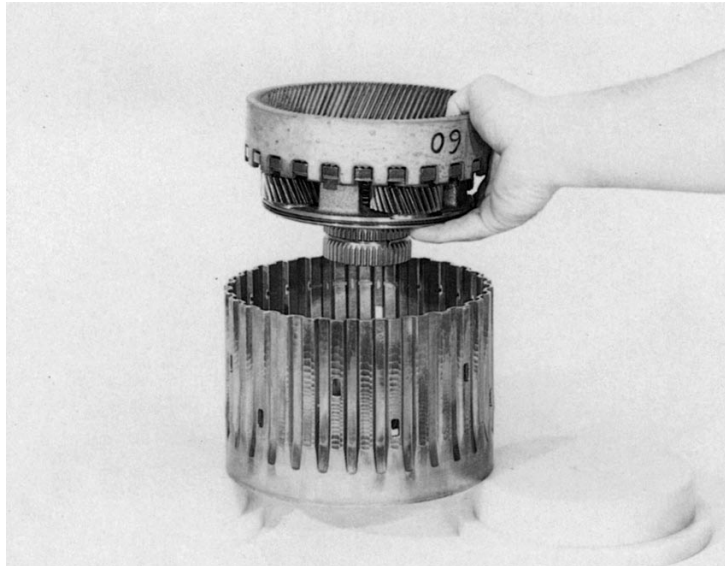

Install sun gear 132.190. Insert angled disc 32.200, axial needle cage 32.210 and axial thrust washer 32.220.

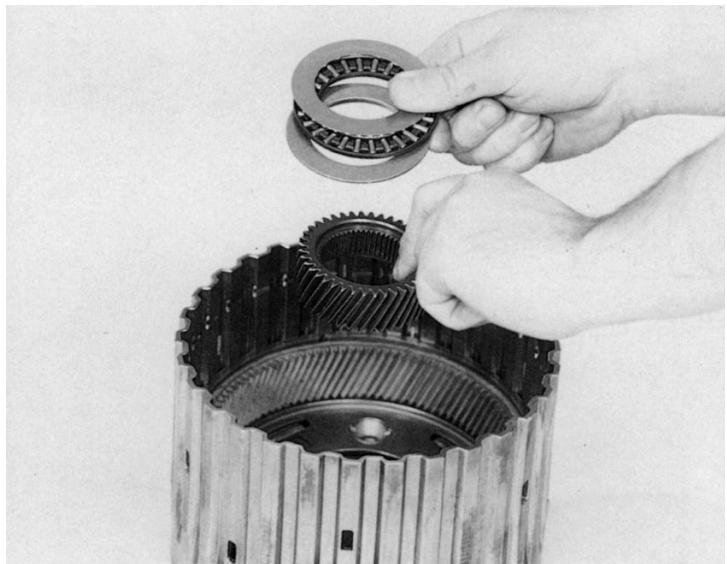

Fit O-ring 32.110/210 to planet carrier II 32.110. Install planet carrier II in ring gear I. For ease of assembly, fit to locating fixture for Tower I, 5 X 46 000 916.

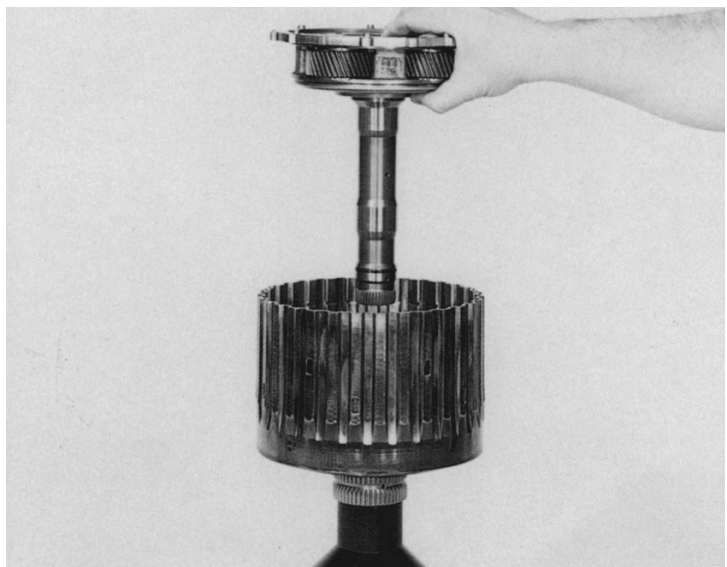

Insert ring gear 11132.240 with outer spline facing upwards and secure with snap ring 32.250. Raise ring gear I slightly to install snap ring.

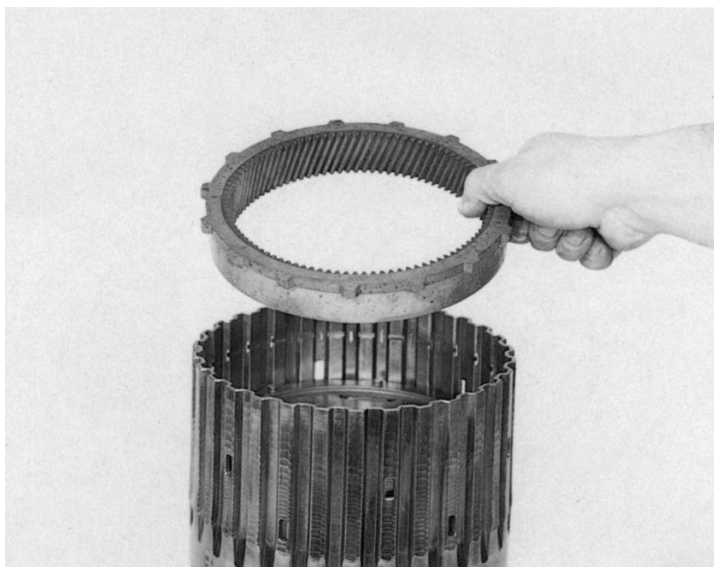

Lift planetary drives (I and II with ring gear III) off fixture. Place planet carrier III 32.010 on fixture and install sun gear 32.050.

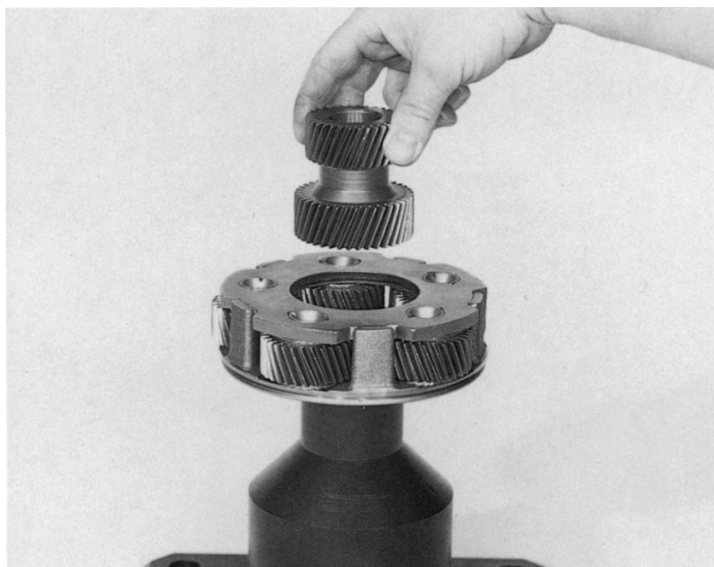

Turn planetary drive while locating on planet carrier.

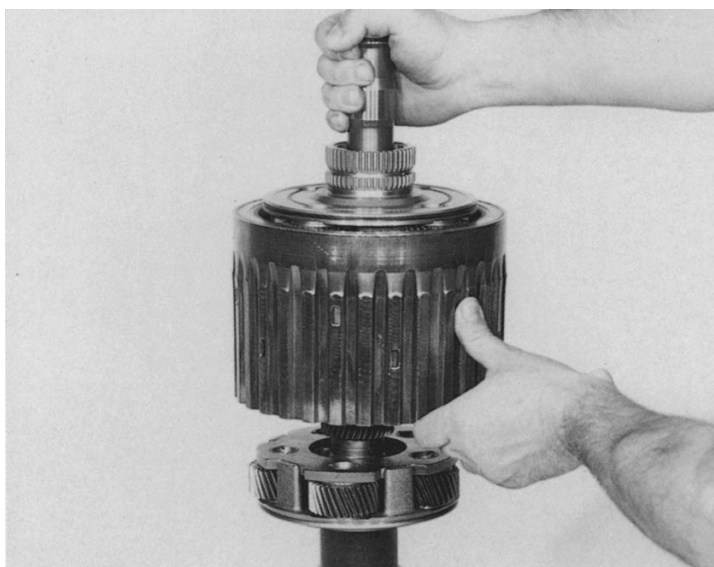

3.3.2 Brakes (E1 and freewheel 2nd gear/ E2 and D)

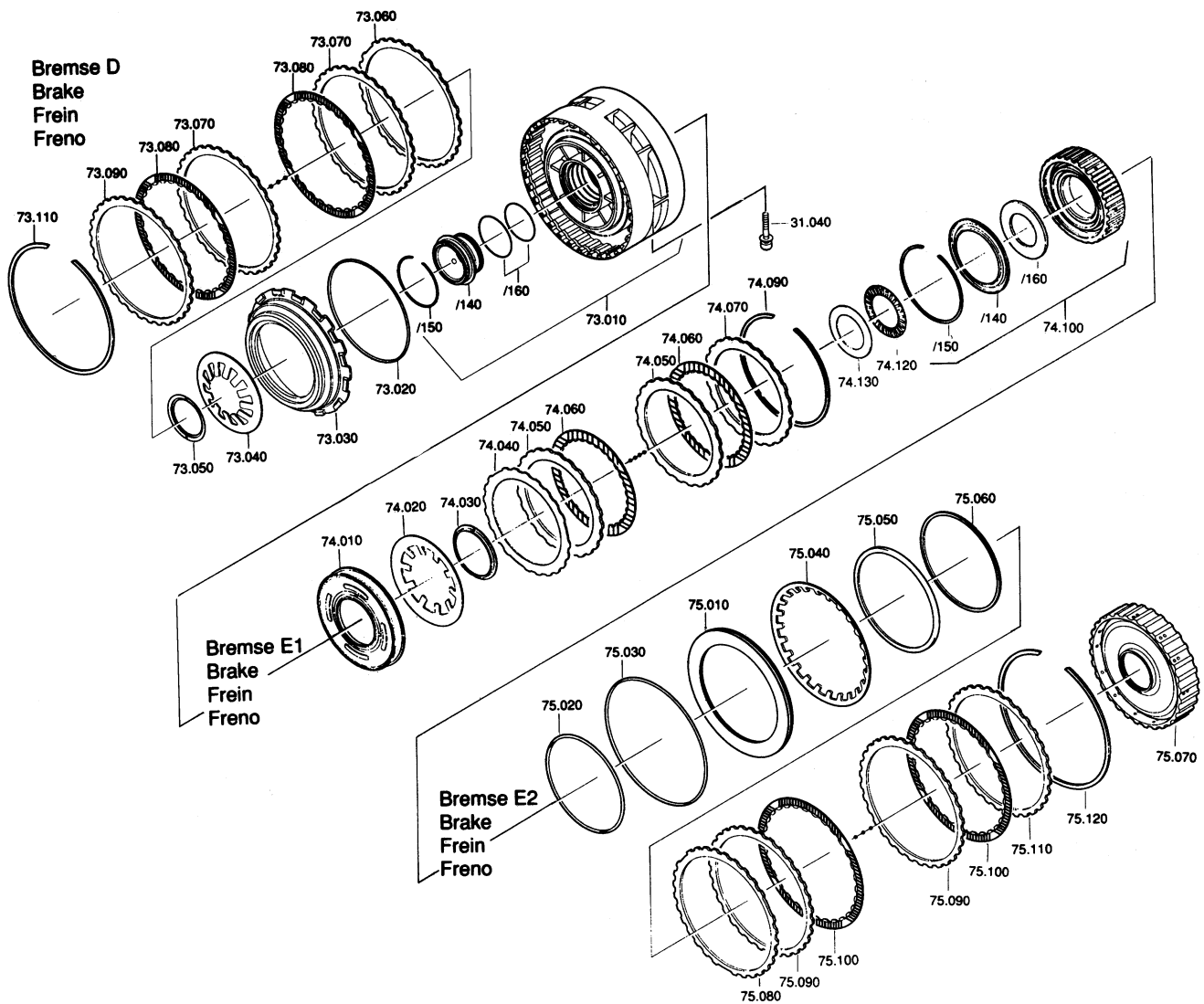

92 112

Apply a light coating of grease (Vaseline) to O-ring on planetary drive. Press disc carrier E2 75.070 on to planetary drive.

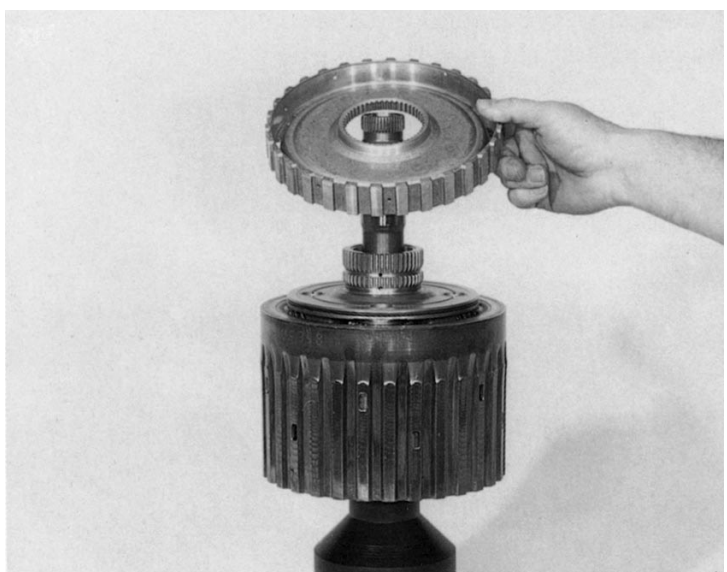

Complete the assembly of the freewheel 2nd gear 74.100. First insert cover disc. Press freewheel cage in with collar facing downwards and install upper cover disc.

Caution!

If installed the wrong way round, sprag function does not operate (wrong direction of rotation).

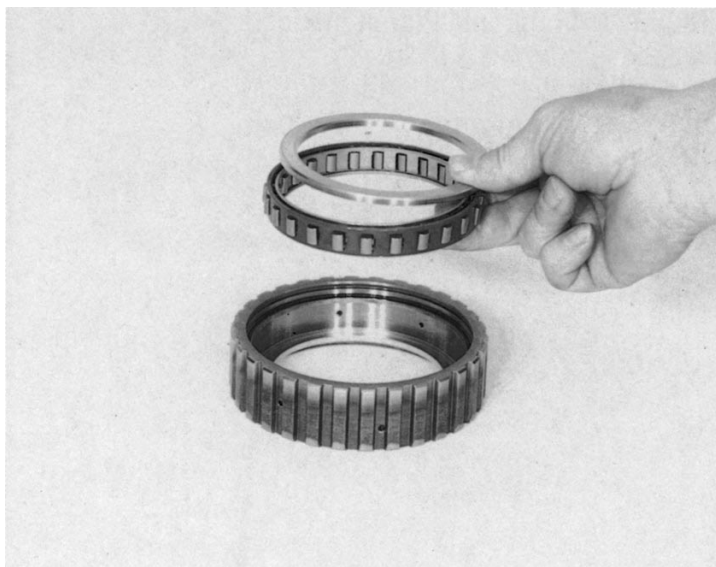

Grip outer race of freewheel and install inner race, rotating it at the same time. Refer to this illustration.

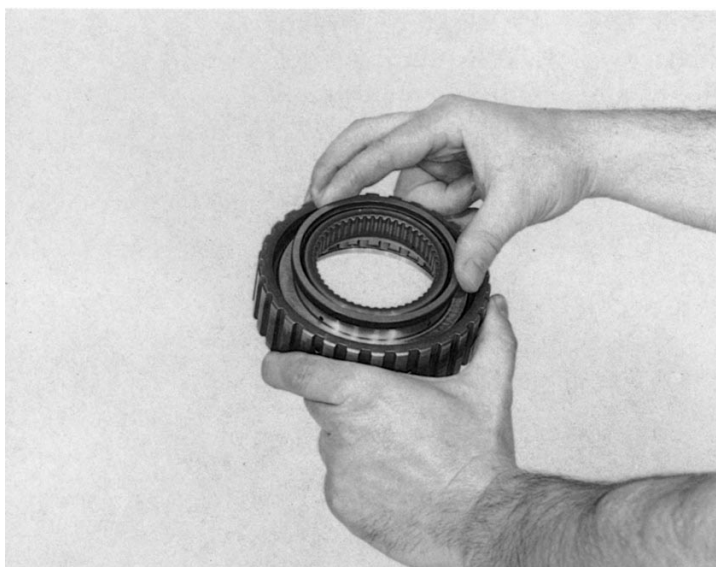

Insert axial thrust washer 74.100/160 and retaining disc 74.100/140. Secure with snap ring 74.100/150.

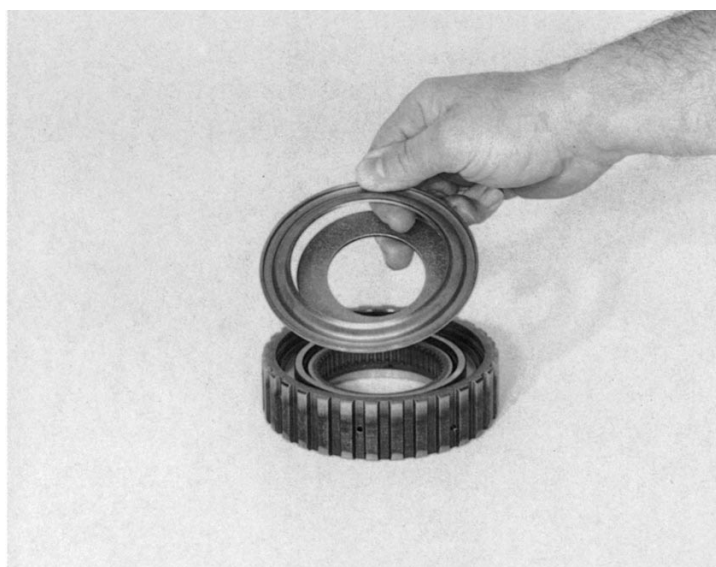

Press the freewheel for 2nd gear onto planetary drive.
Assemble axial needle cage 74.120 and angled disc 74.130.

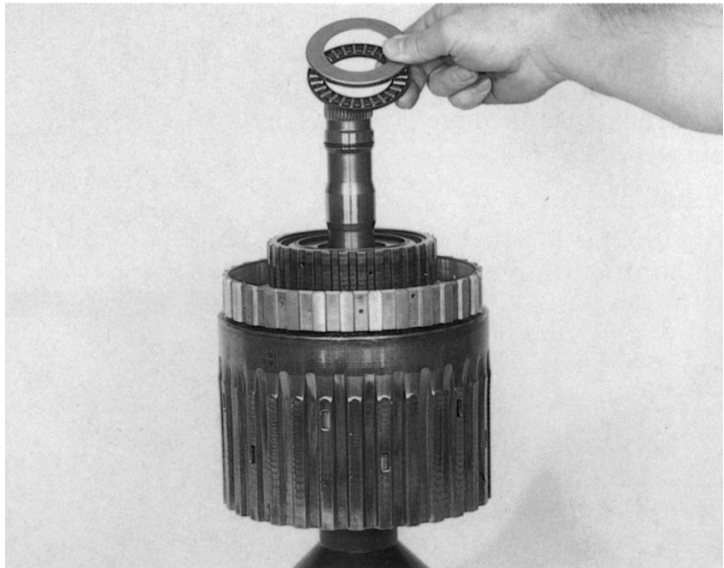

Complete assembly of cylinder DE 73.010. First fit 2 O-rings 73.010/160 to bush 73.010/140 and press these into cylinder DE. Secure bush with snap ring 73.010/150.

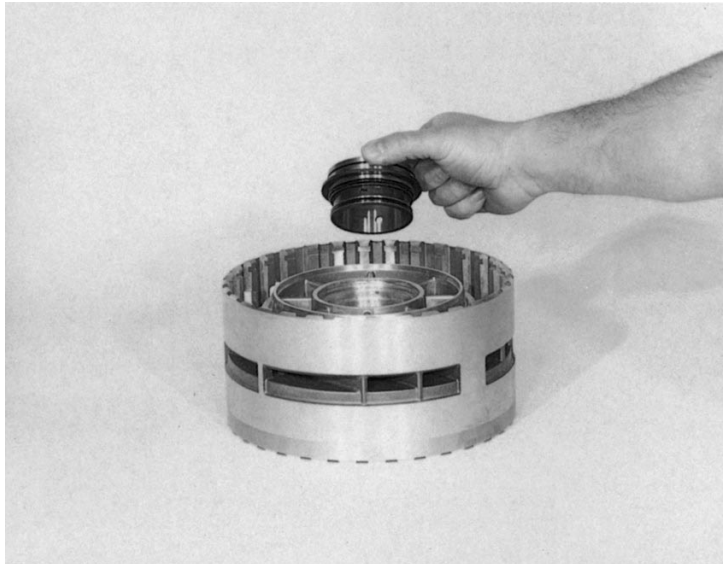

Rotate cylinder DE.
Apply light coating of grease (Vaseline) to sealing lips and press into cylinder DE.

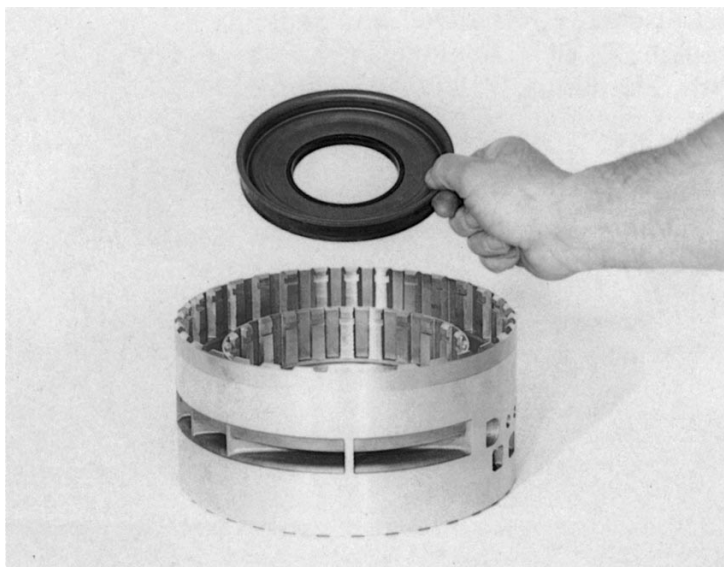

Insert plate spring 74.020.
Using assembly bracket
5 X 46 000 928, press down plate spring
under mandrel press and secure with
split retaining ring 74.030.

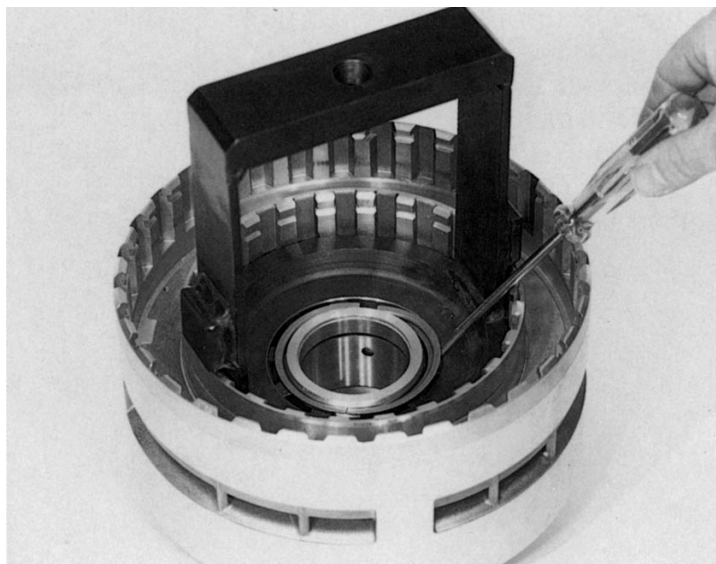

Fit new O-rings 75.020 and 75.030 to
piston E2 75.010 and apply a light
coating of grease (Vaseline).
Press piston E2 into cylinder DE.

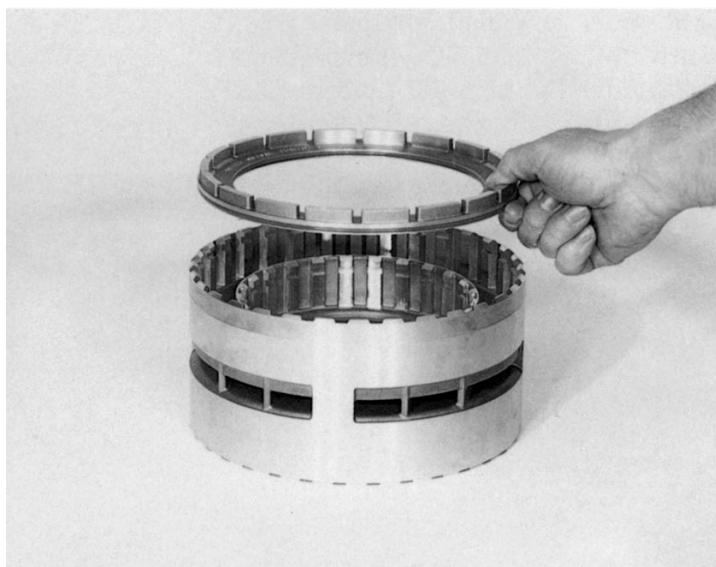

Insert plate spring E2 75.040.
Install retaining disc 75.050, press down
plate spring under mandrel press using
assembly bracket 5 X 46 001 064 and
secure with snap ring 75.060.

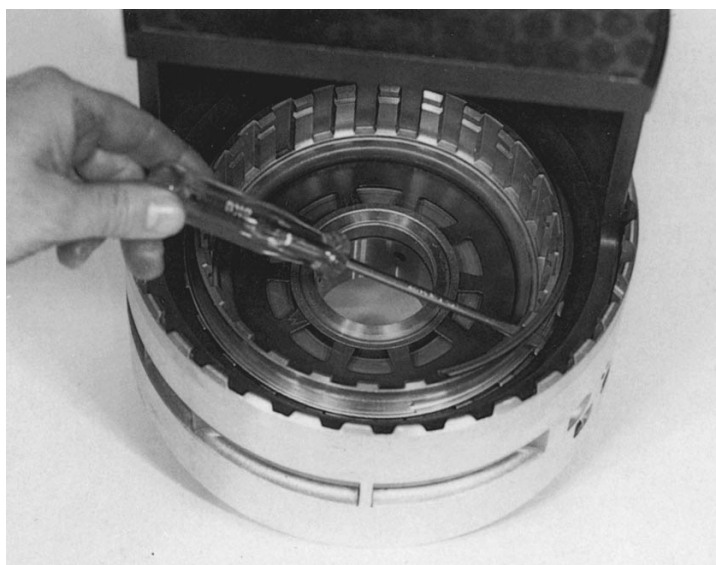

Rotate cylinder DE through 180 degrees and fit O-ring 73.020 on cylinder hub. Apply light coating of grease (Vaseline) to O-ring and sealing lips of piston D 73.030. Press piston D into place.

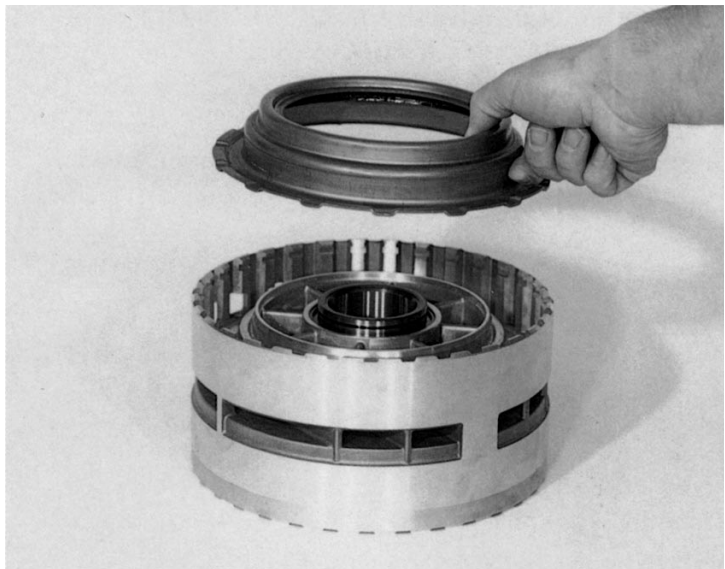

Insert plate spring D 73.040. Use assembly bracket 5 X 46 000 928 to press plate spring D down under mandrel press and secure with split retaining ring 73.050.

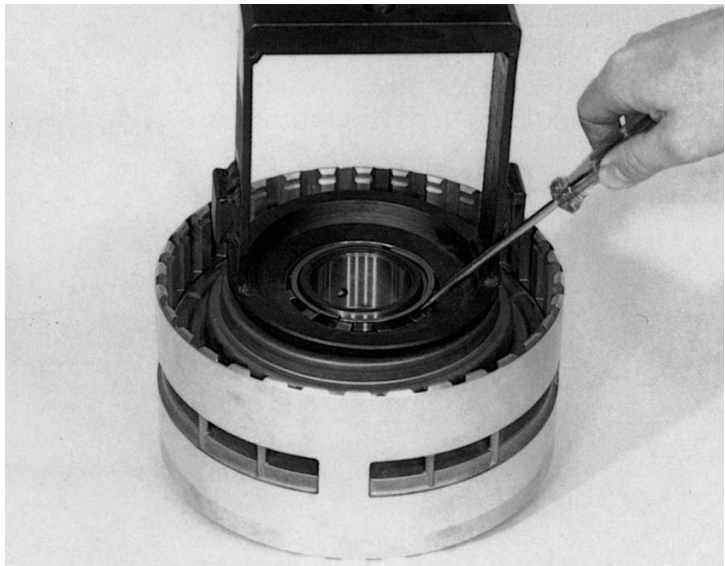

Install complete disc pack D, starting with spring disc 73.060. Then add alternate outer disc 73.070 and lined disc 73.080. Secure top outer disc 73.090 with snap ring 73.110.

Caution!

Adjustment work
(see Item 1.4.2, Page 5/2)

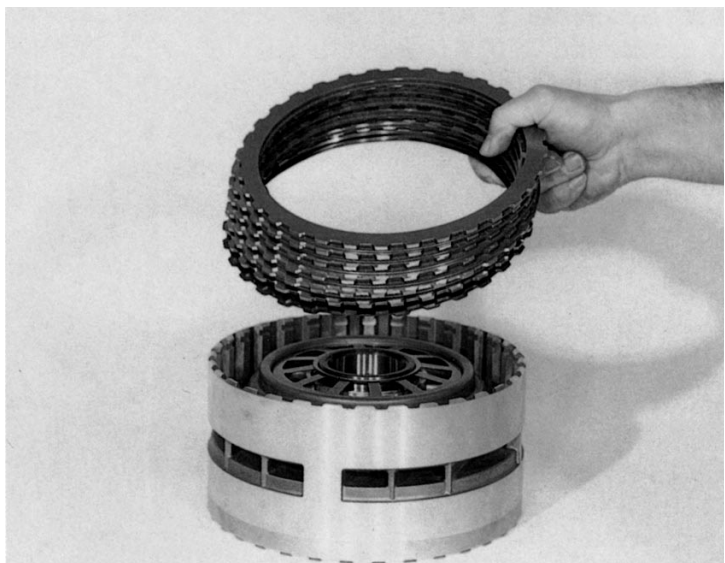

Rotate cylinder DE and insert complete disc pack E2, starting with spring disc 75.080. Then add alternate outer disc 75.090 and lined disc 75.100. Secure top outer disc 75.110 with snap ring 75.120.

Caution!

Adjustment work
(see Item 1.4.3, Page 5/3)

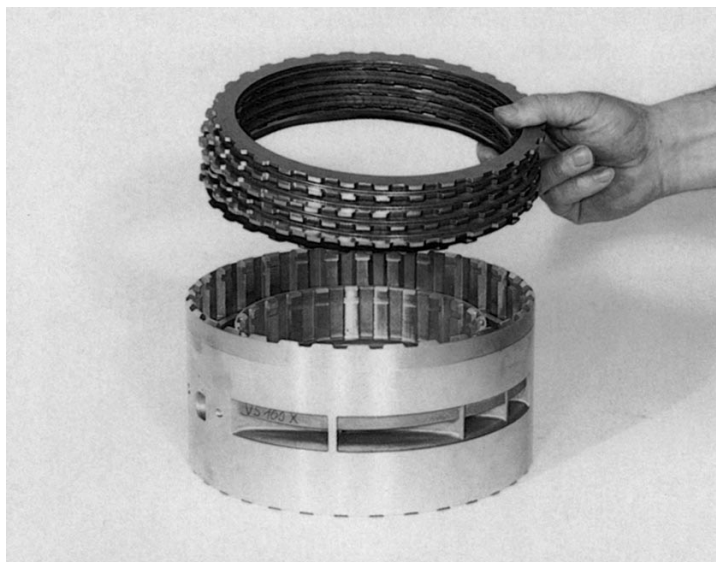

Install complete disc pack E1, starting with spring disc 74.090. Then add alternate outer disc 74.050 and lined disc 74.060. Secure top outer disc 74.070 with snap ring 74.090.

Caution!

Adjustment work
(see Item 1.4.4, Seite 5/4)

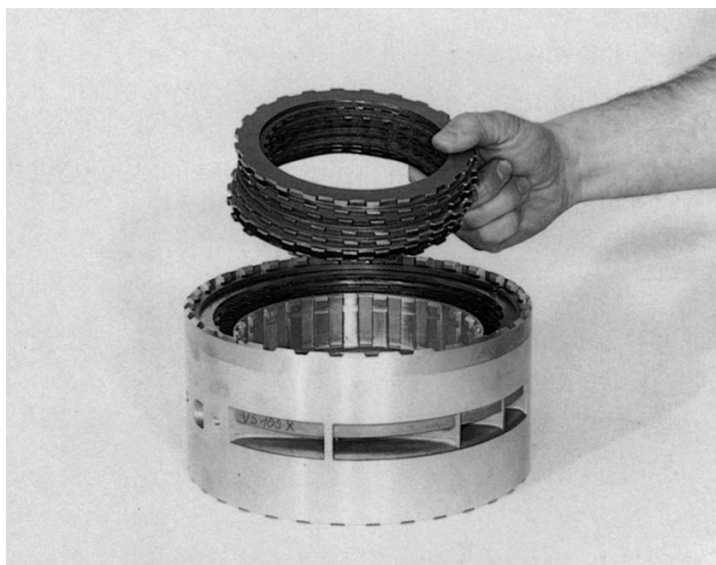

Complete assembly of Tower I by fitting brakes (E1, E2 and D) to the planetary drive, rotating unit backwards and forwards until the disc packs fully locate in the splines. Inspection dimension: Shaft (planet spider) to bush (cylinder DE): approx. 45 mm.

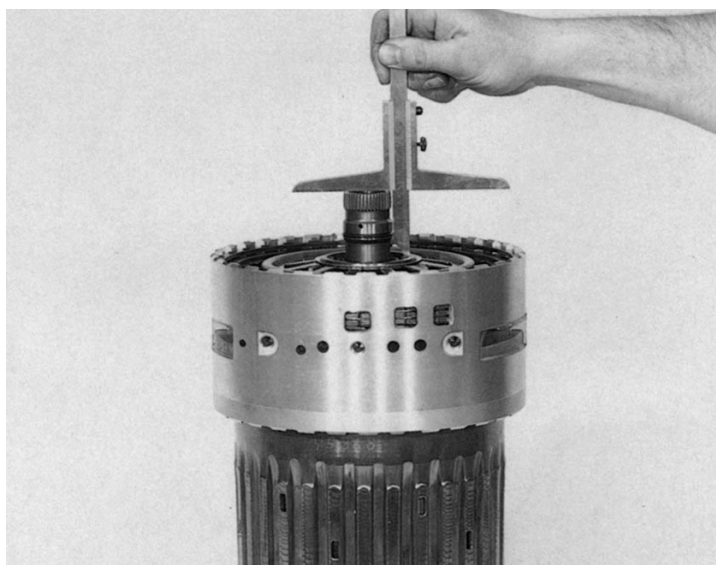

Screw lifter 5 X 46 000 857 into Tower I and align bores for tower bolt connection. Using a crane, carefully place Tower I into the transmission housing.

Caution!

Brakes must not catch on the transmission housing and should lift clear of the planetary drive.

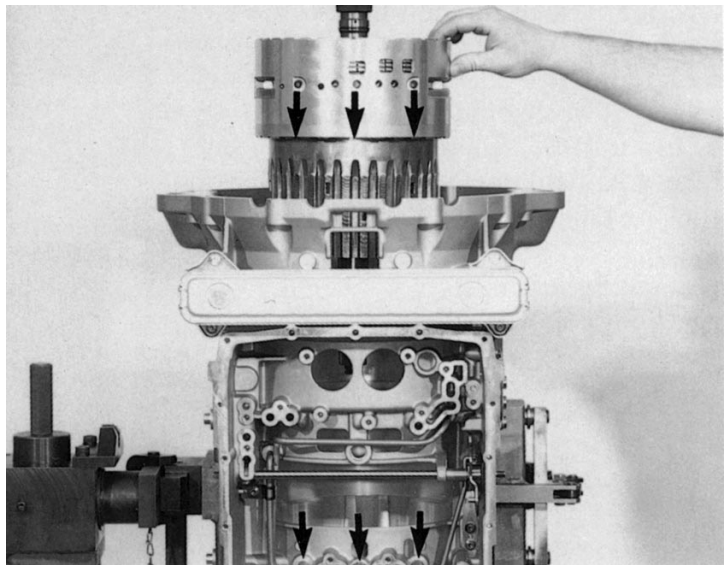

Caution!

Comply with bolt tightening instructions:

1. Screw three machine screws 31.040 approx. two turns.
2. First preload middle screw to 30 Nm, then tighten to 63 Nm.
3. Initially tighten outer screws to 15 Nm, then to 30 Nm and finally to 63 Nm.

(Wrench size = Torx - TX 50)

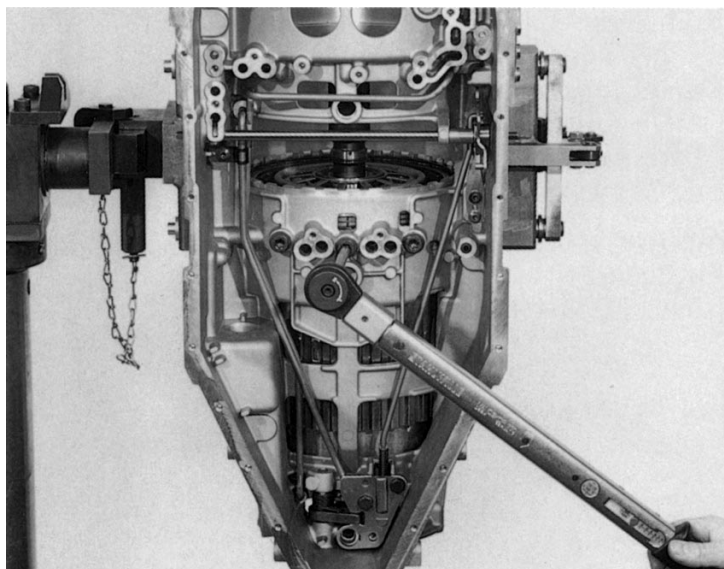

3.4 Output

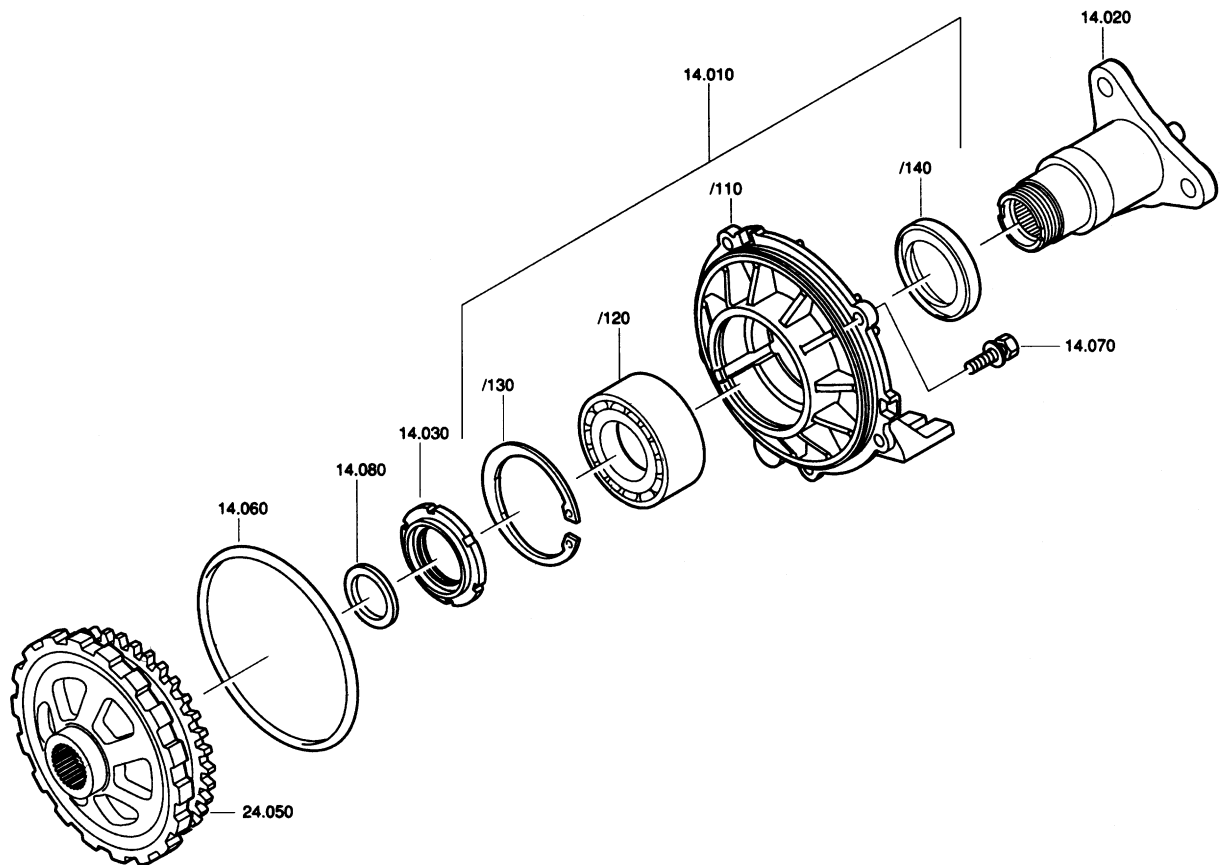

92 139

Fit extension 14.010/110 to the locating face of the press-in fixture 5 X 46 000 945.

Fit ball bearing 14.010/120 to the press-in pin of the tool, press the extension down under the mandrel press the extension down under the mandrel press and secure using snap ring 14.010/130.

Caution!

The two inner bearing races must not be accidentally interchanged or fitted the wrong way round.

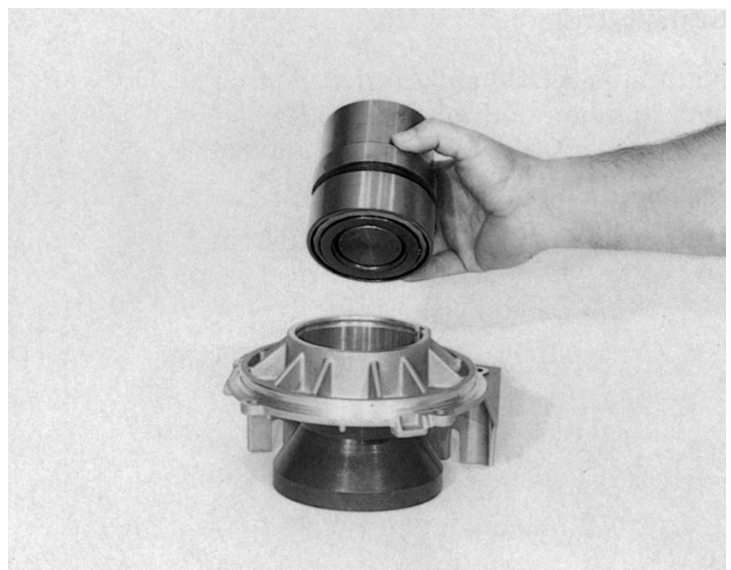

92 140

Rotate extension, ensuring that outer bearing races do not fall out. Use assembly drift 5 X 46 000 952 in a mandrel press to fit shaft seal 14.010/140.

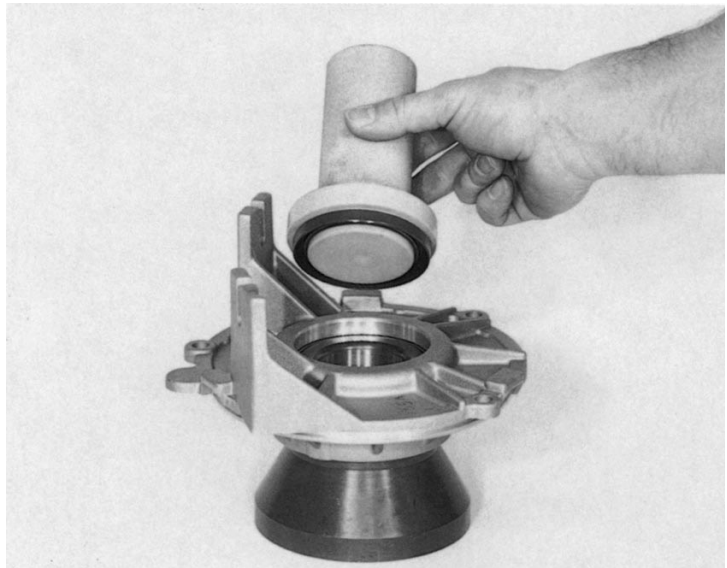

92 141

Fit output flange 14.020 to counter support 5 X 46 000 946. Fit extension to output flange. Fit O-ring 14.060 to extension.

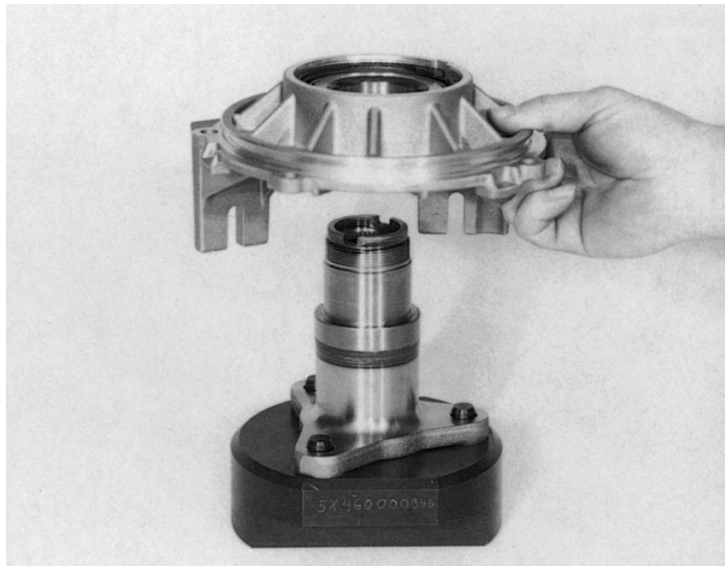

92 142

Use a vise!

Fit grooved nut 14.030 to output flange and tighten down using grooved nut insert 5 X 46 000 787.

(Tightening torque = 120 Nm)

Secure grooved nut at 2 points around circumference.



Rotate transmission through 180 degrees. Install park pawl gear 24.050 and fit shim 14.080.

Caution!

Adjustment work
(see Item 1.4.5, Page 5/5)

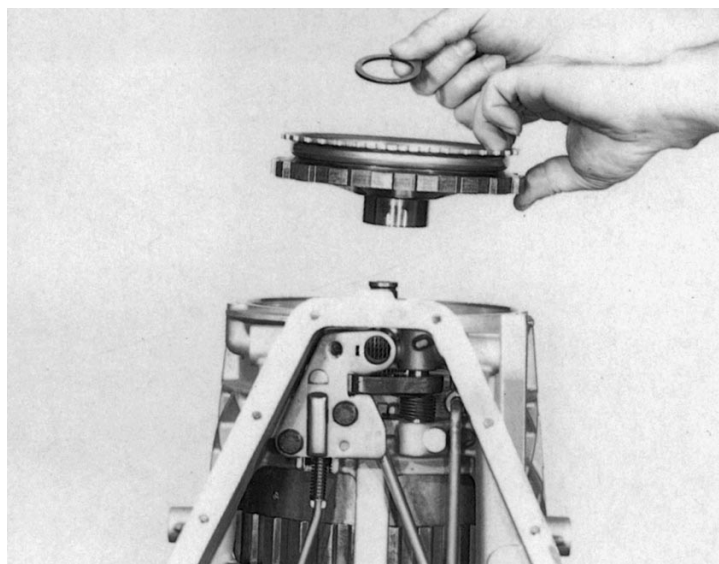

Fit output and tighten down with 5 hex screws 14.070.

(Width across flats = 13 mm)
(Tightening torque = 23 Nm)

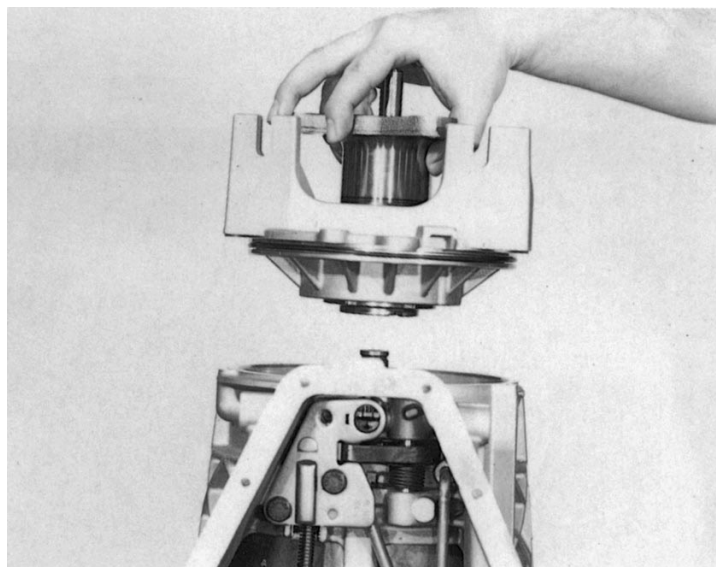

3.5 Tower II (input with clutches A, C and B)

3.5.1 Clutches A, C (input)

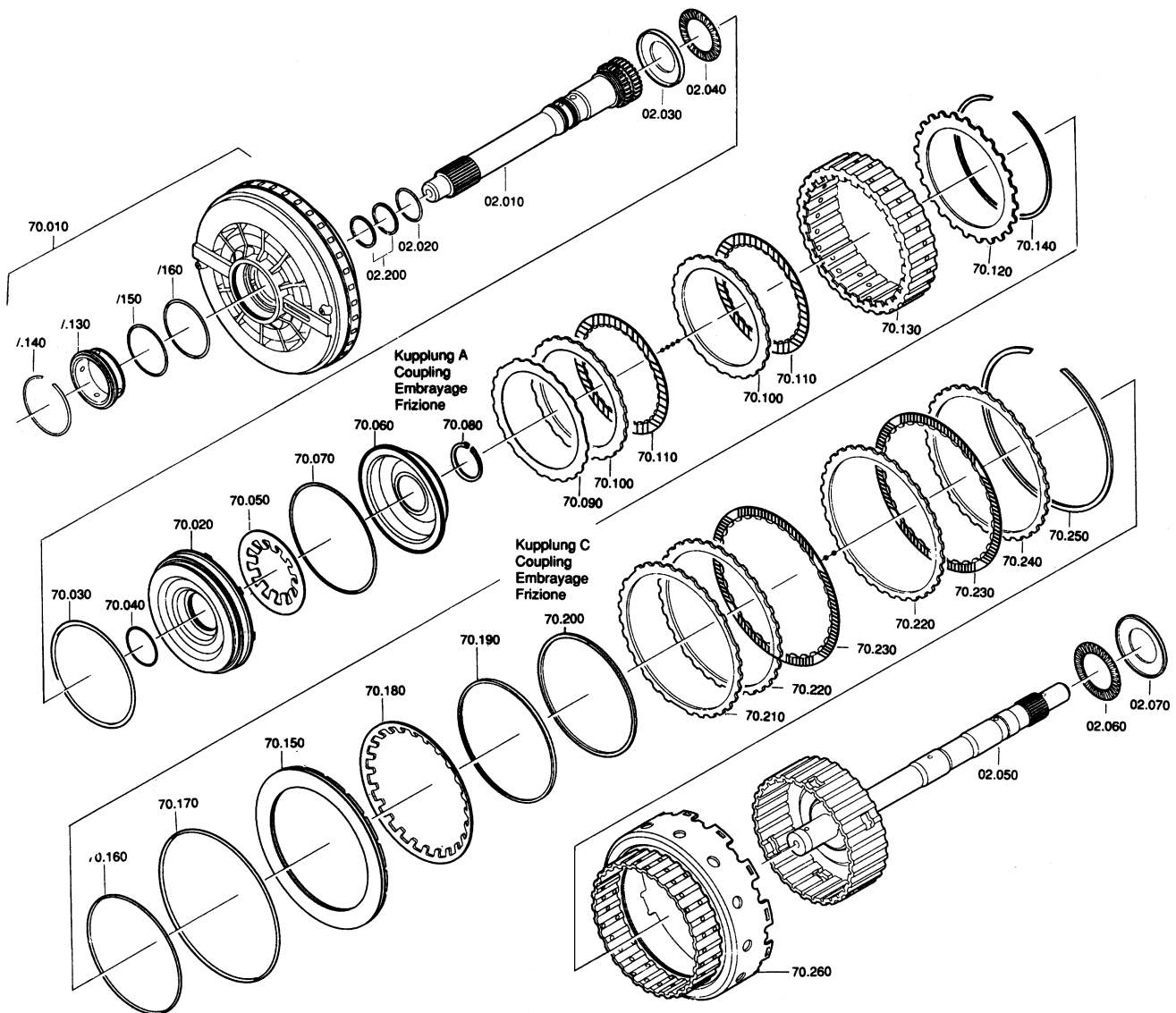

92 148

Complete assembly of cylinders A + C 70.010. For this, fit two O-rings 70.010/150 and 70.010/160 to bush 70.010/130 and apply light coating of grease (Vaseline). Press bush into cylinder A + C and secure using snap ring 70.010/140.

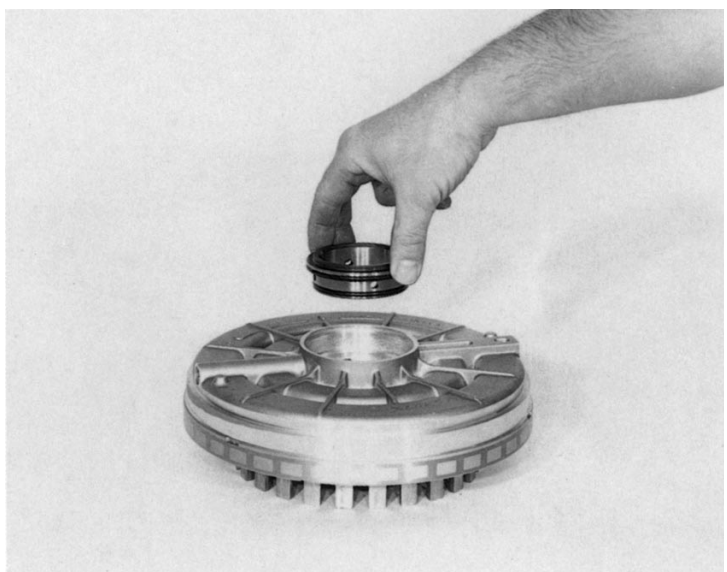

Fit new O-rings 70.040 and 70.030 to piston A 70.020 and apply a light coat of grease (Vaseline). Press piston A into cylinders A + C.

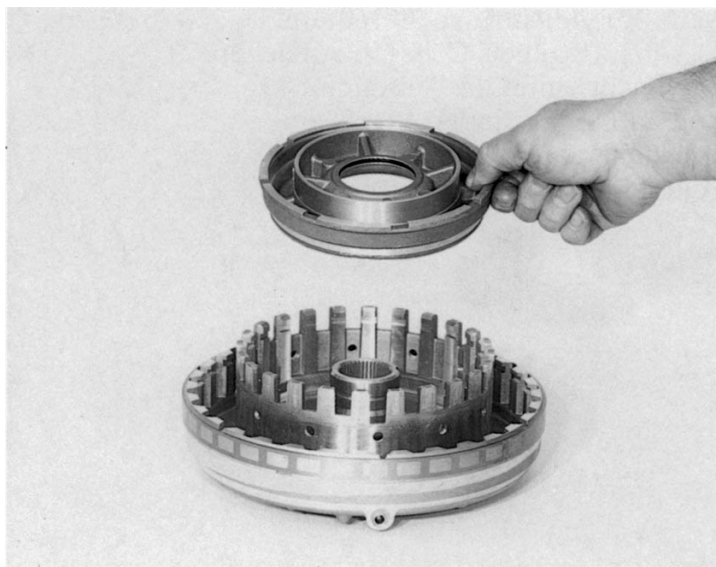

Fit new O-ring 70.070 on oil dam 70.060 and apply light coating of grease (Vaseline). Press plate spring 70.050 in cylinder A + C and fit oil dam.

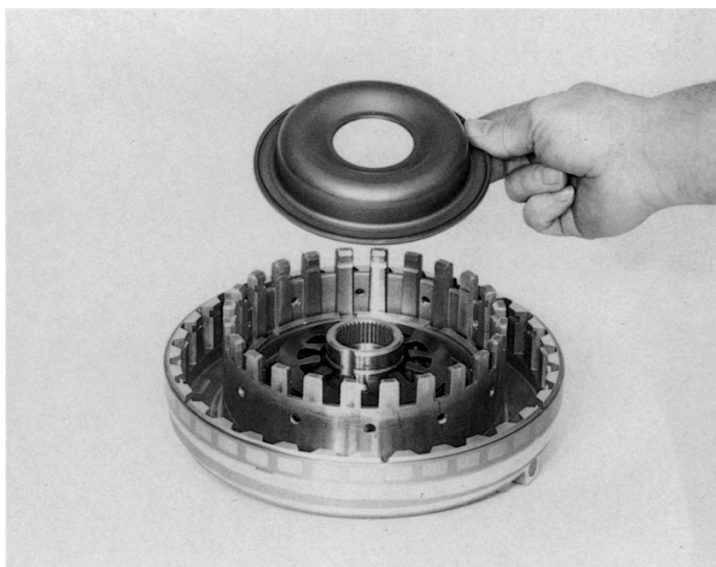

Use assembly bracket 5 X 46 000 931 to press down oil dam under mandrel press and secure with retaining ring 70.080.

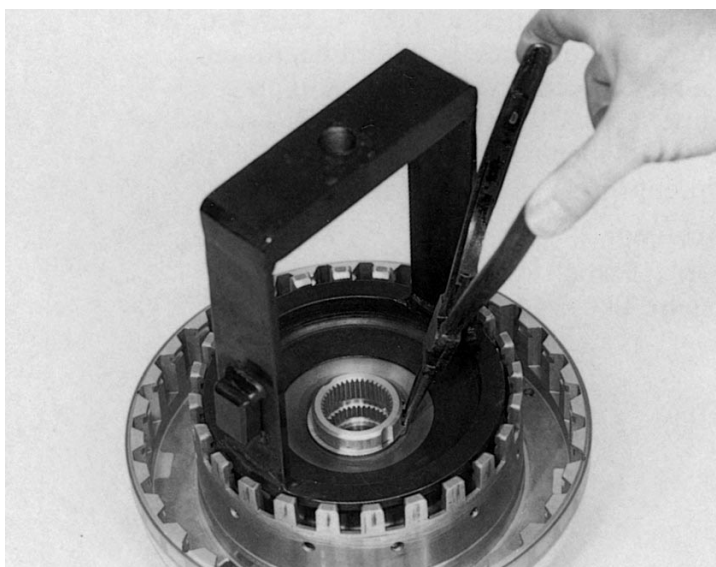

Fit new O-rings 70.160 and 70.170 to piston C 70.150 and apply a light coat of grease (Vaseline). Press piston C into cylinder A + C.
Fit plate spring 70.180.

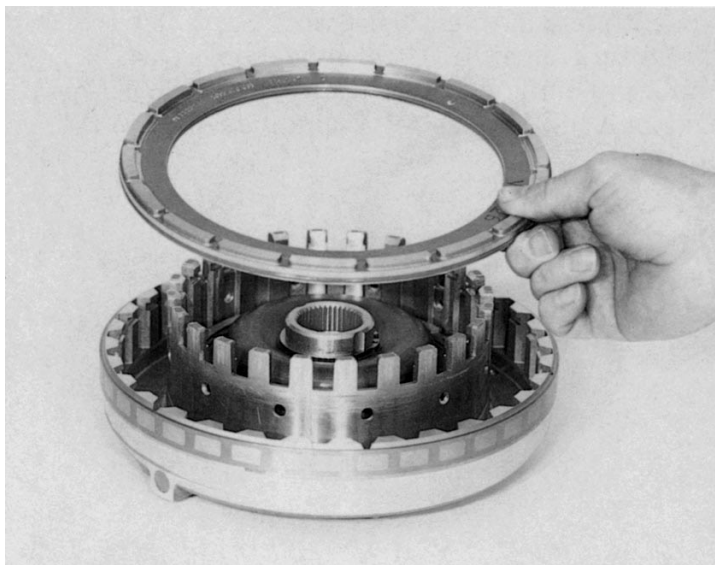

Use assembly bracket 5 X 46 061 064 to press plate springs down under mandrel press.
Install retaining disc 70.190 and calculate size required.
Carefully fit snap ring 70.200 over cylinder hub and clip into place using screwdriver.

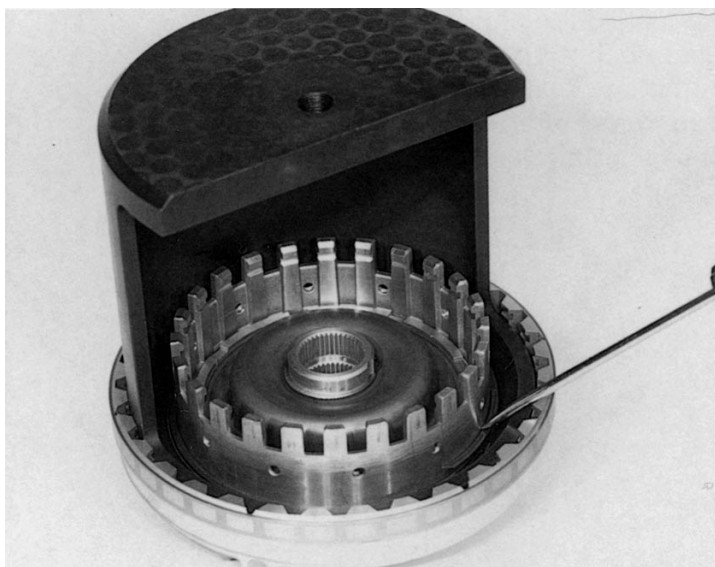

Install complete disc pack C, starting with spring disc 70.210. Then add alternate outer disc 70.220 and lined disc 70.230. Secure top outer disc 70.240 with snap ring 70.250.

Caution!

Adjustment work
(see Item 1.4.6, Page 5/6)

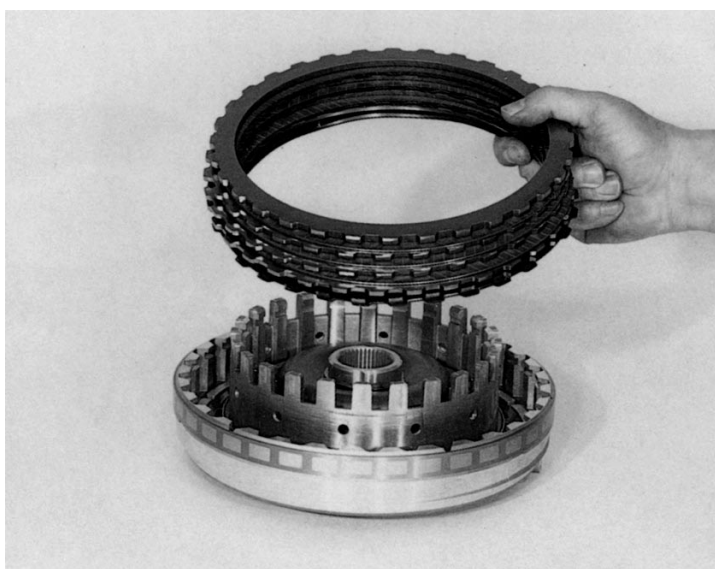

Install complete disc pack A starting with spring disc 70.090. Then add alternate outer disc 70.100 and lined disc 70.110. Secure top outer disc 70.120 with snap ring 70.140.

Caution!

Adjustment work
(see Item 1.4.7, Page 5/7)

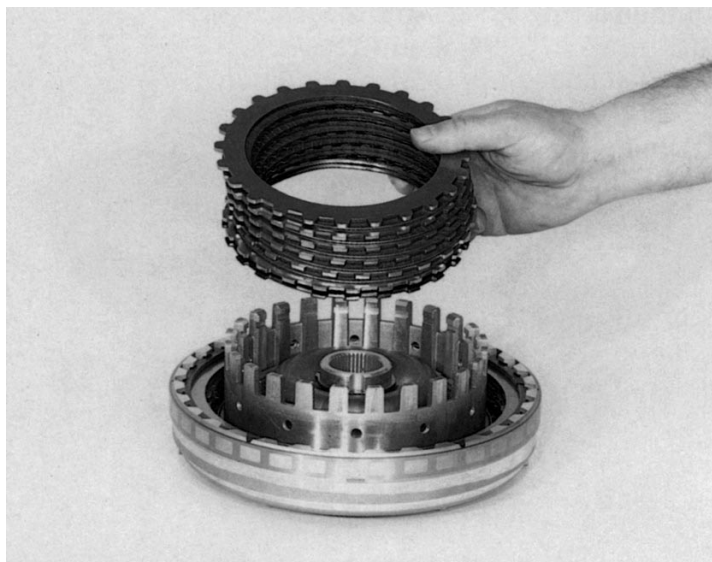

Remove snap ring and end disc from disc pack A. Rotate disc carrier C 70.260 to install.

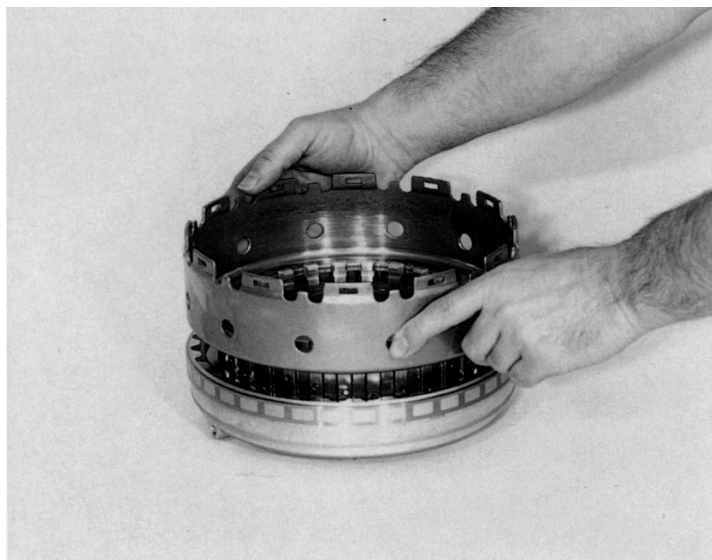

Fit inner disc carrier B 70.130, refit end disc and secure using snap ring.

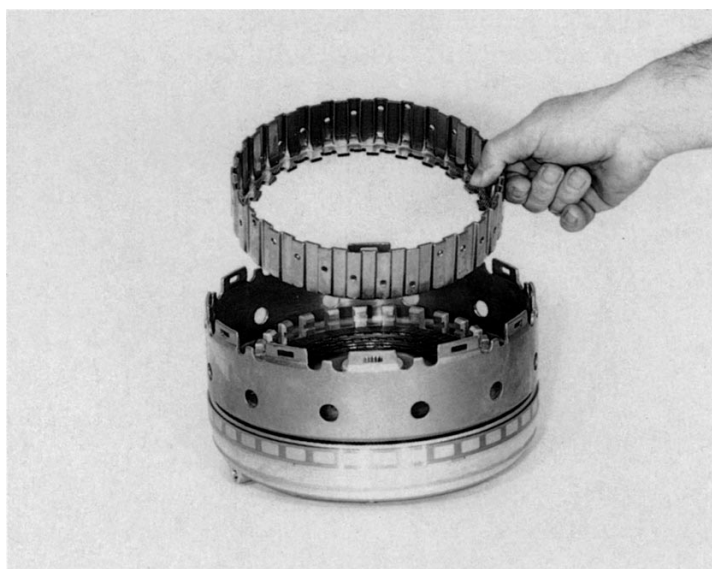

Fit O-ring 02.020 and 2 sealing rings 02.200 to input shaft 02.010 and apply a light coat of grease (Vaseline). Place clutch A, C on locating fixture 5 X 46 000 917 and press input shaft.

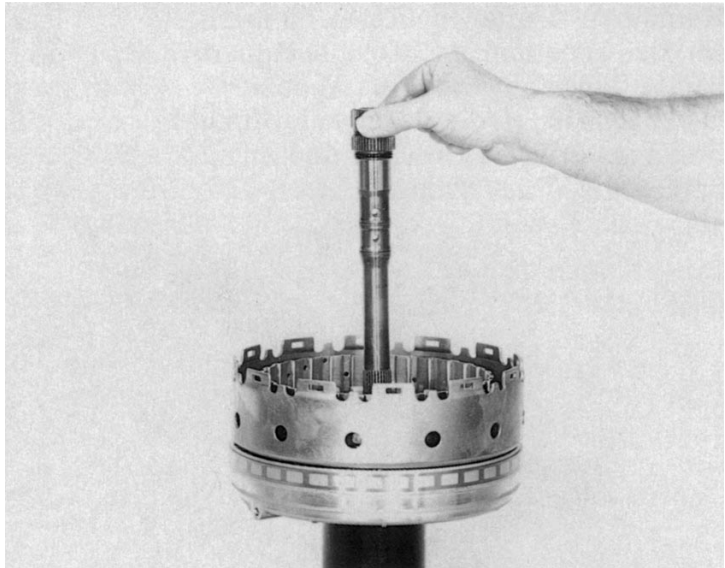

Place angled disc 02.030 and axial needle cage 02.040 on hub of cylinder A, C.

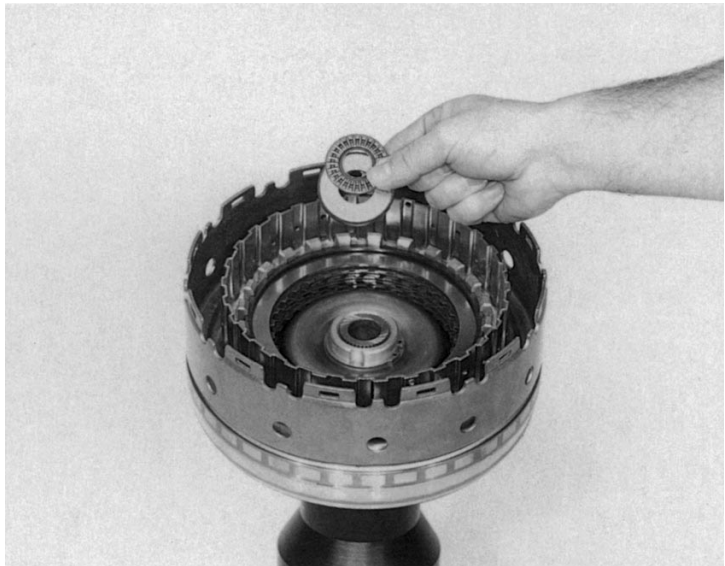

Align discs of clutch A and install intermediate shaft 02.050, rotating to do so. Fit axial needle cage 02.060 and angled disc 02.070 on to intermediate shaft.

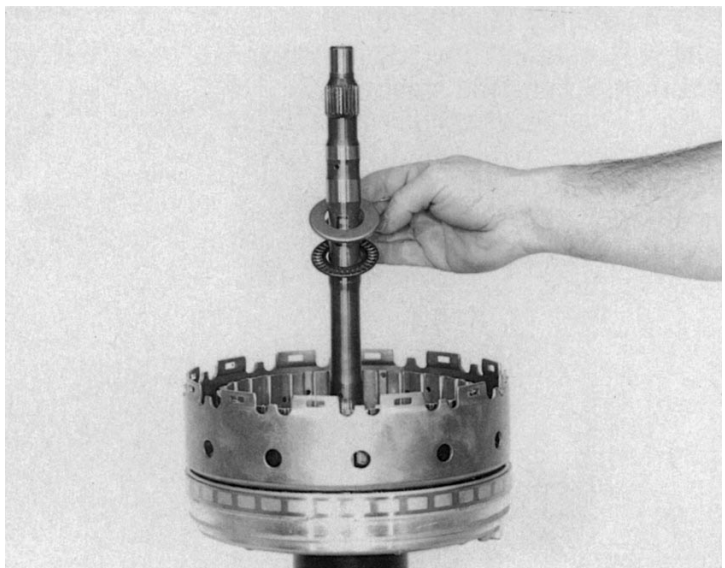

3.5.2 Clutches B (input)

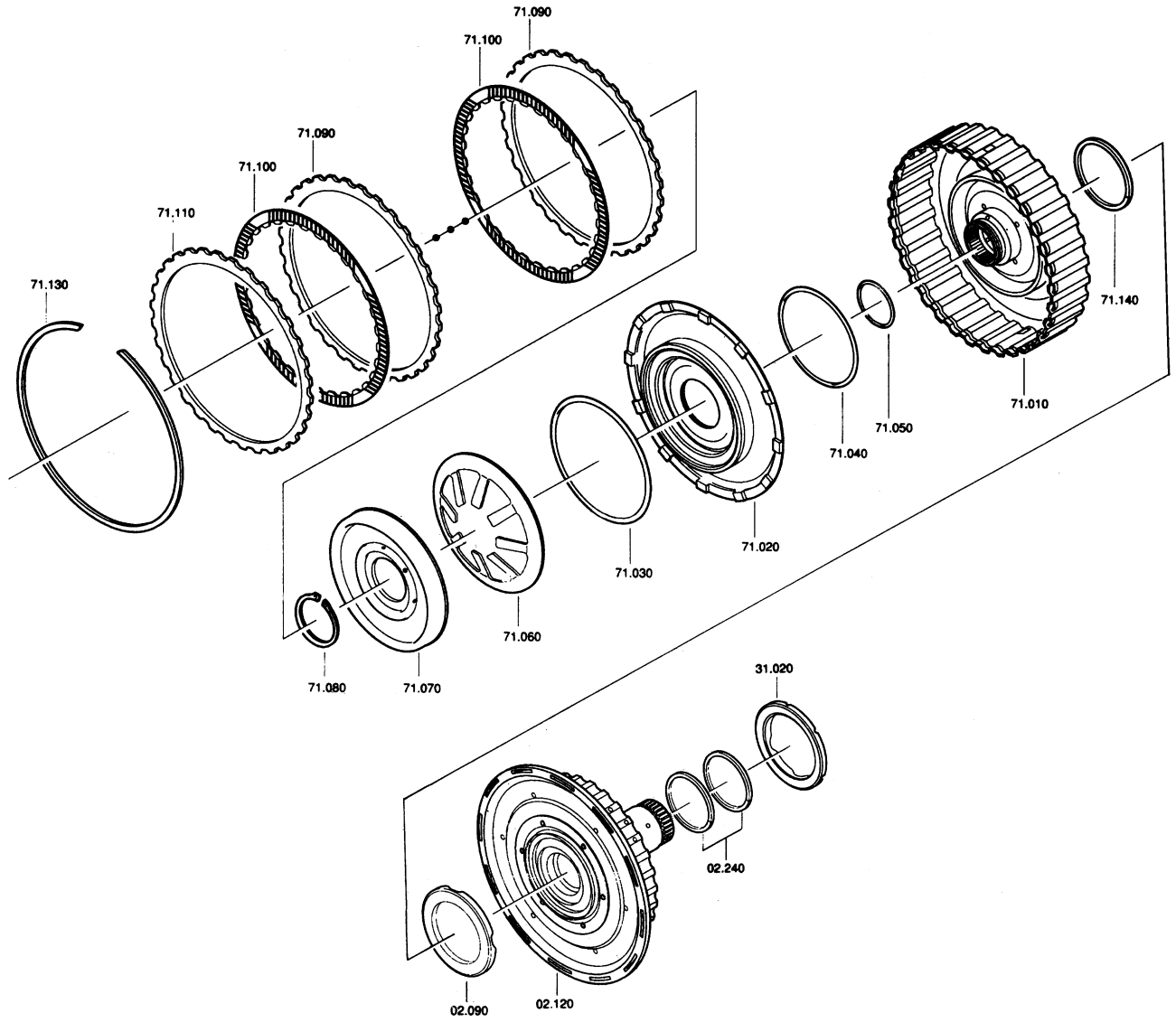

92 167

Fit 3 O-rings 71.030, 71.040 and 71.050 on piston B 71.020, and grease lightly (with Vaseline).
Fit rectangular section ring 71.140 to cylinder B 71.010.
Press piston B into cylinder B.

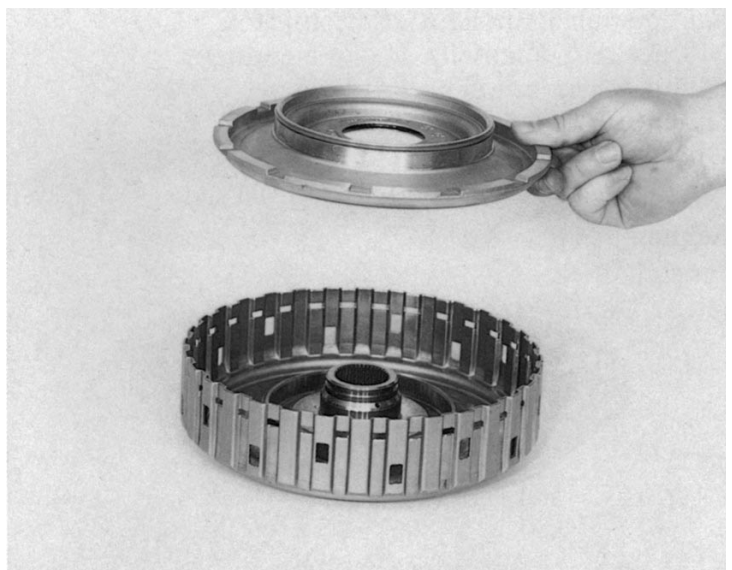

Install plate spring 71.060 and oil dam 71.070.

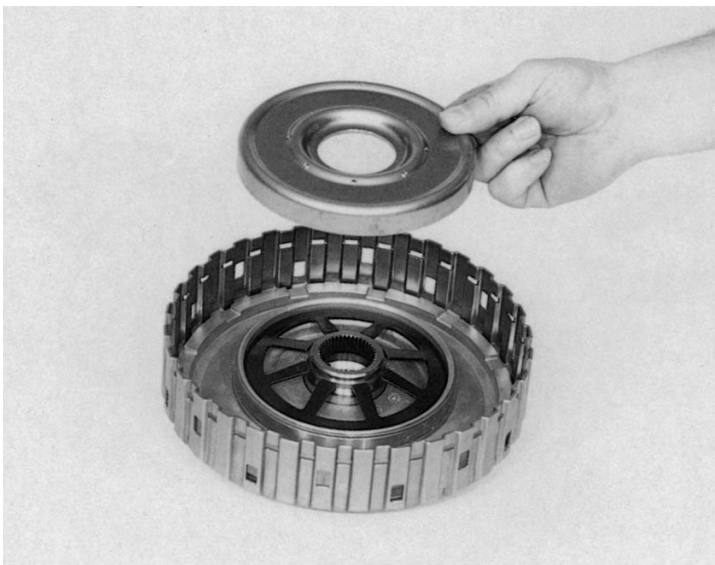

Use assembly bracket 5 X 46 000 928 to press down oil dam under mandrel press and secure using retaining ring 71.080.

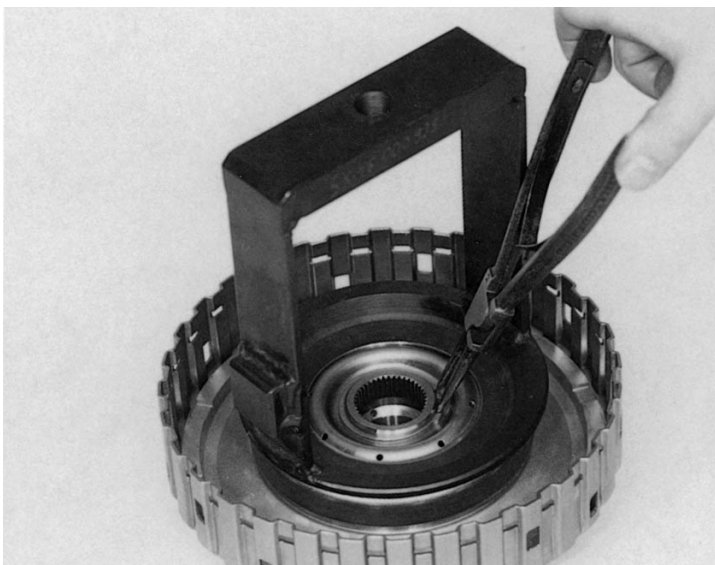

Install complete disc pack B. Start with outer disc 71.090. Then add alternate lined disc 71.100 and outer disc. Secure top outer disc 71.110 with snap ring 71.130.

Caution!

Adjustment work
(see Item 1.4.8, Page 5/8)

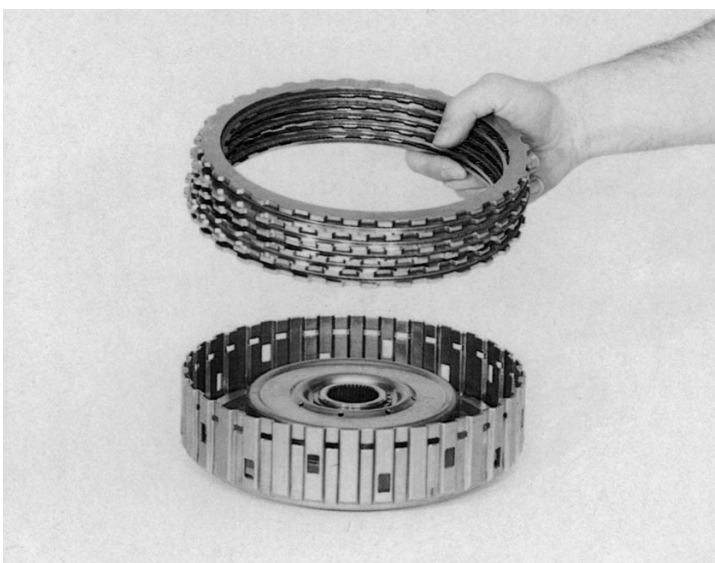

Align disc pack B and install complete clutch, rotating to and from to do this. Fit axial needle bearing 02.090 to hub of cylinder B. Check installation position of bearing (see this illustration).

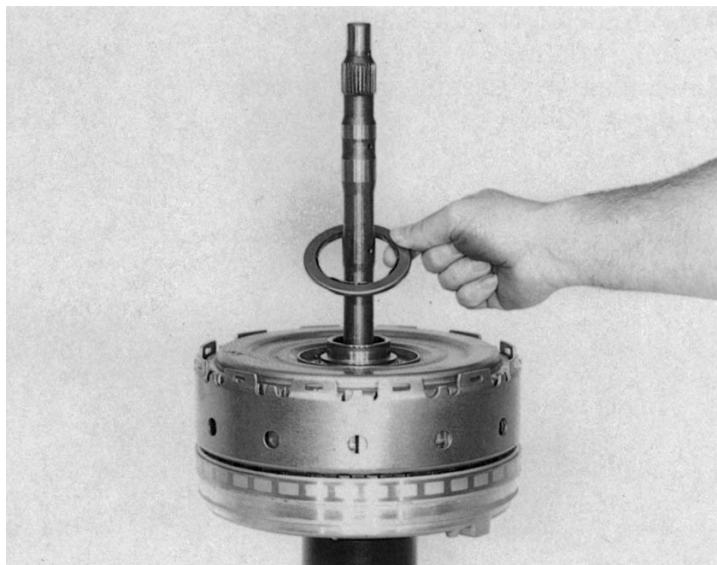

Fit 2 rectangular section rings 02.240 to sun gear shaft 02.120 and grease lightly (Vaseline). Fit sun gear shaft.

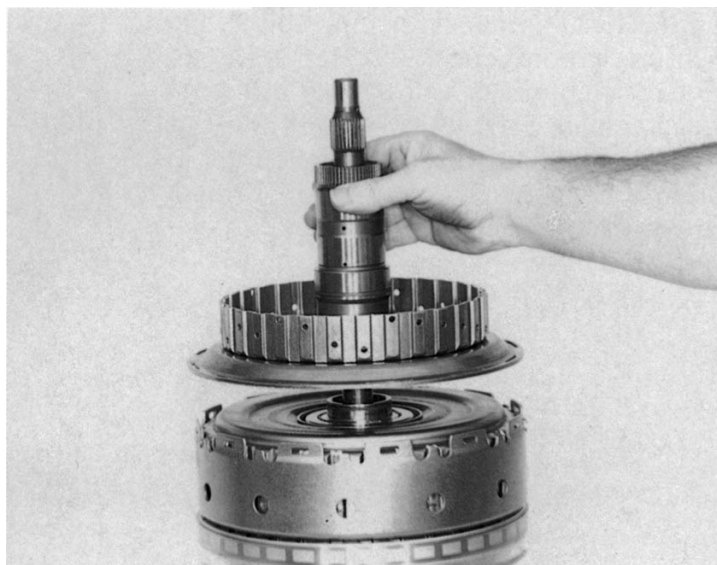

Bend disc carrier C inwards 6 times using bending fixture 5 X 46 001 005. Procedure: First bend two opposing tabs, then bend 4 other evenly-spaced tabs.

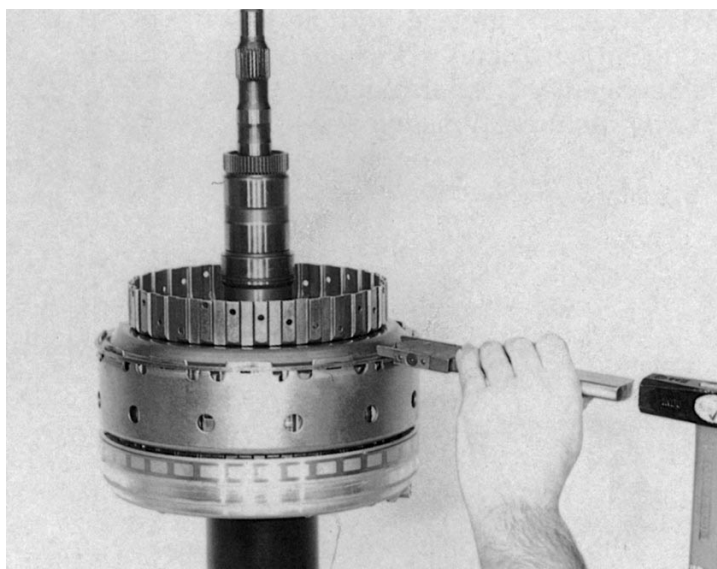

Fit axial needle bearing 31.020 to Tower I.
Installation position of bearing:
see this illustration.

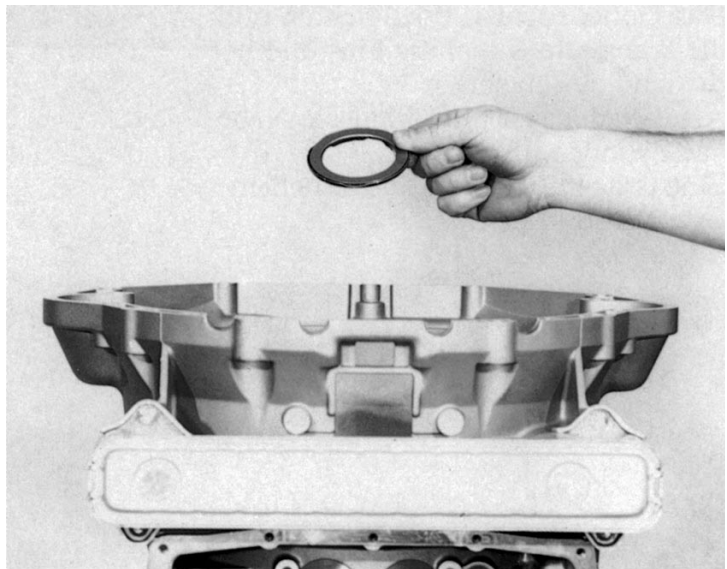

Rotate Tower II through 180 degrees in locating fixture.
Fit lifter 5 X 46 000 949 with adapter 5 W 46 000 003 on input shaft. Align discs of brake D and install Tower II using crane.

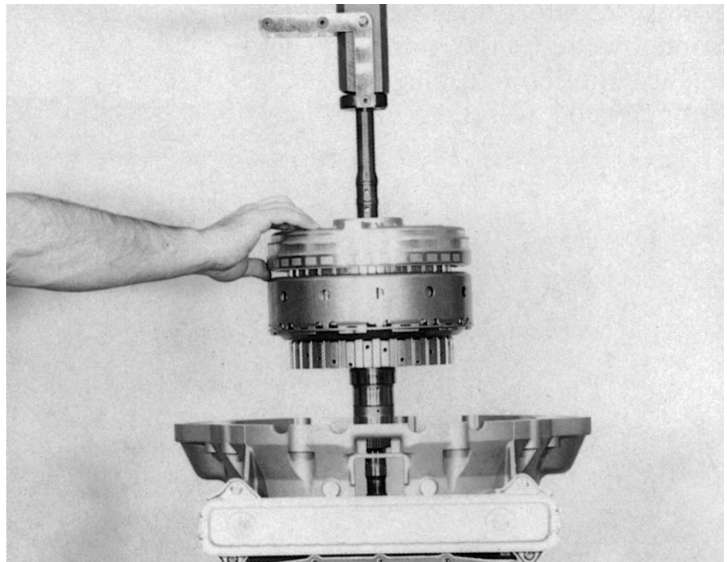

When correctly assembly, the discs of brake D are not under pressure: check using screwdriver. Remove lifting fixture.

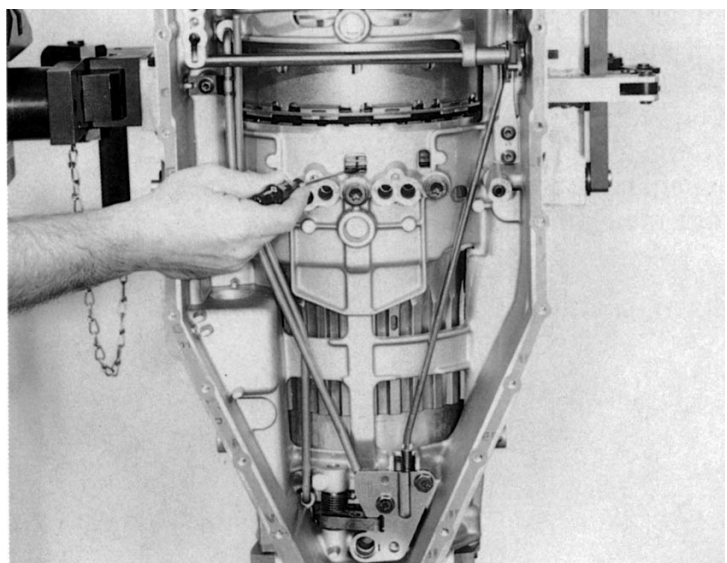

3.6 Oil supply

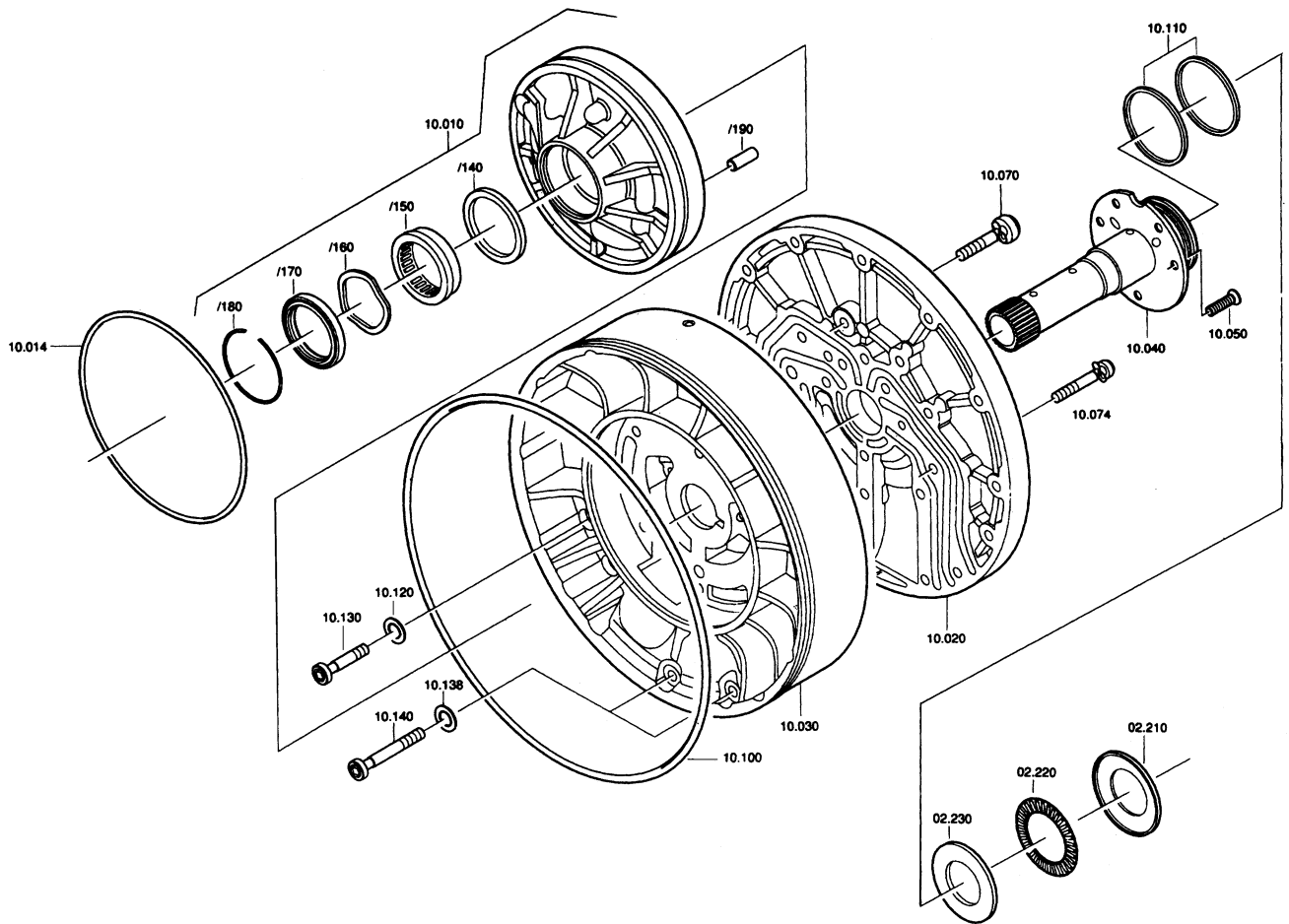

92 179

Complete assembly work on pump 10.010.
Initially, fit sealing ring 10.010/140 in pump housing and press needle bearing 10.010/150 down in a mandrel press with assembly drift 5 X 46 000 954.



Fit corrugated disc 10.010/160, press shaft seal 10.010/170 into pump housing with assembly sleeve 5 X 46 000 953 and secure using snap ring 10.010/180.

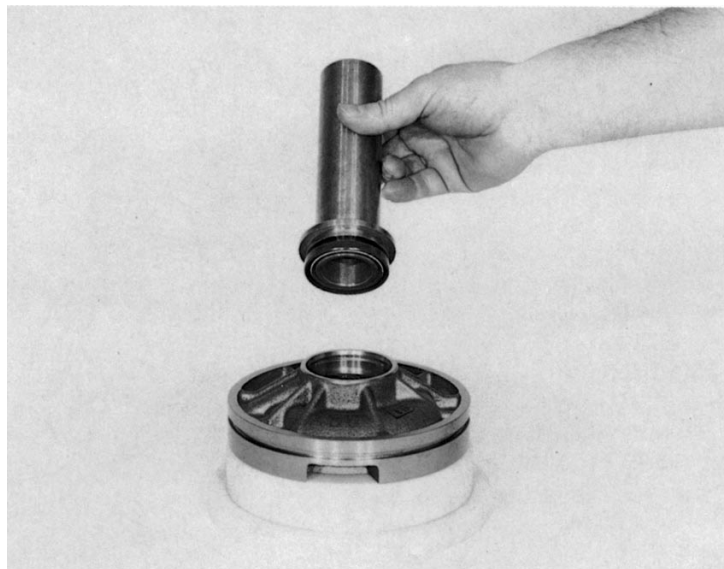

The pump must be assembled in such a way that one mark is clearly visible on the pump ring gear and two marks are visible on the impeller. Press in sleeve 10.010/190. Fit O-ring 10.014.

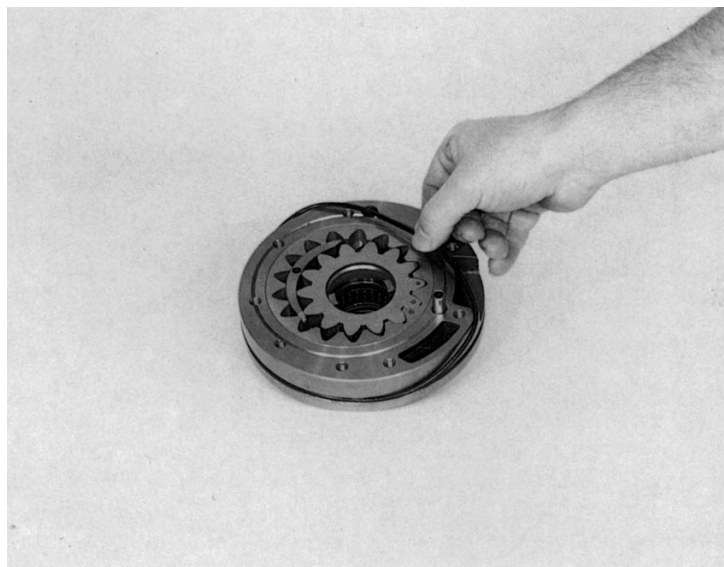

Fit 2 rectangular section rings 10.110 to stator shaft 10.040.

In order to fit the stator shaft on to the intermediate plate and centering plate, these two components must be aligned. Assembly procedure is described on next page.

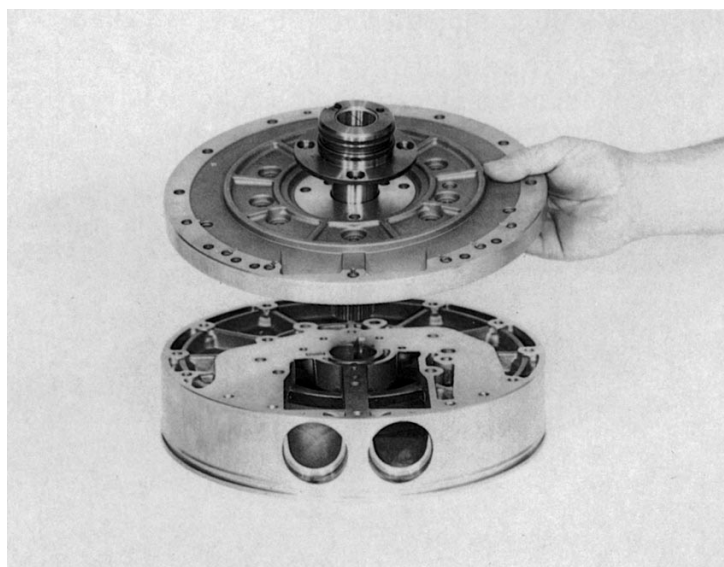

Procedure:

First place centering plate on suitable base 10.030. Screw in two dowel pins 5 X 46 001 007.

Place intermediate plate 10.020 on centering plate.

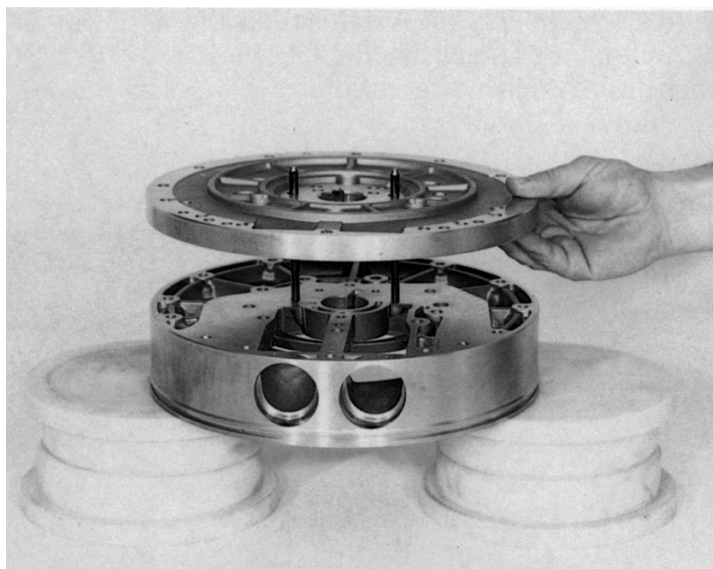

Heat entire unit to approx. 70 degrees Celsius using hot air blower. Place stator shaft over dowel pins and secure initially with 3 countersunk screws 10.050.

Remove dowel pins and screw in the other 2 machine screws.

(Wrench size = Torx - TX 27)

(Tightening torque = 10 Nm)

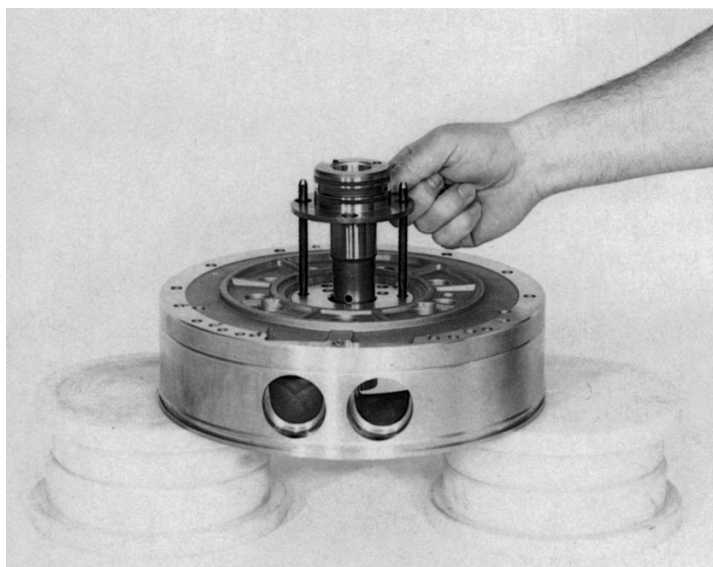

Fit complete pump unit over stator shaft from below and secure with 9 machine screws 10.070 and 1 machine screw 10.074.

(Wrench size = Torx - TX 27)

(Tightening torque 10.070 = 10 Nm)

(Tightening torque 10.074 = 5 Nm)

Note!

The pump can be checked for ease of movement with sleeve 5 X 56 000 021.

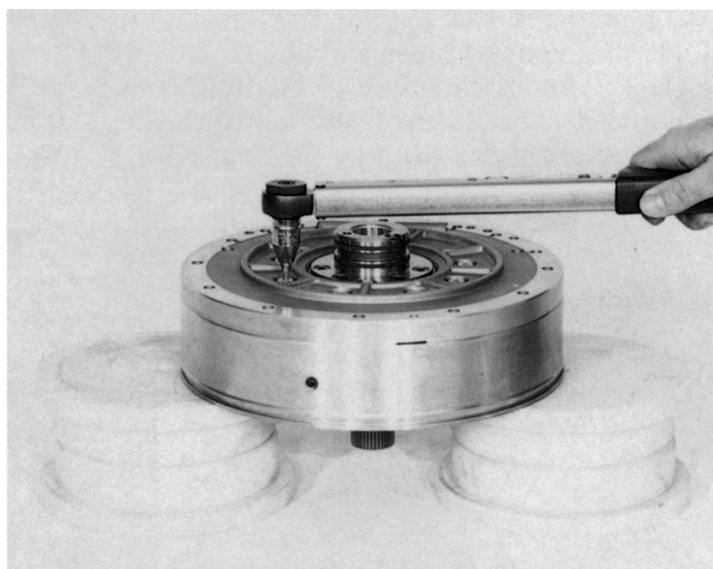

Fit angled disc 02.210, axial needle cage 02.220 and shim 02.230 over input shaft and on to clutch AC.

Caution!

Adjustment work
(see Item 1.4.9, Page 5/9)

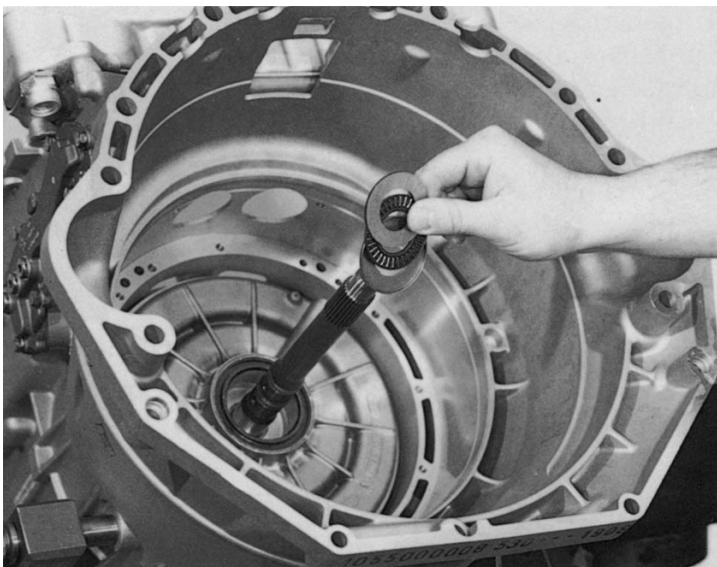

Fit O-ring 10.100 to centering plate and coat with ATF oil.
Use assembly fixture 5 X 46 000 563 to install complete oil supply unit, rotating unit to do so. Align suction and pressure channels in oil supply unit and transmission housing.

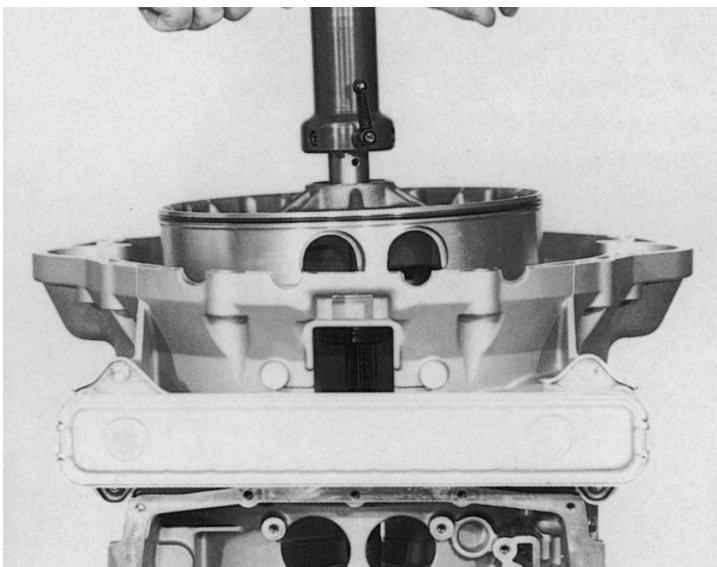

Tighten down oil supply unit with 12 machine screws 10.130 and new Usit rings 10.120 as well as 2 machine screws 10.140 and new Usit rings 10.138.

(Wrench size = Torx - TX 27)
(Tightening torque = 10 Nm)

Check end float.

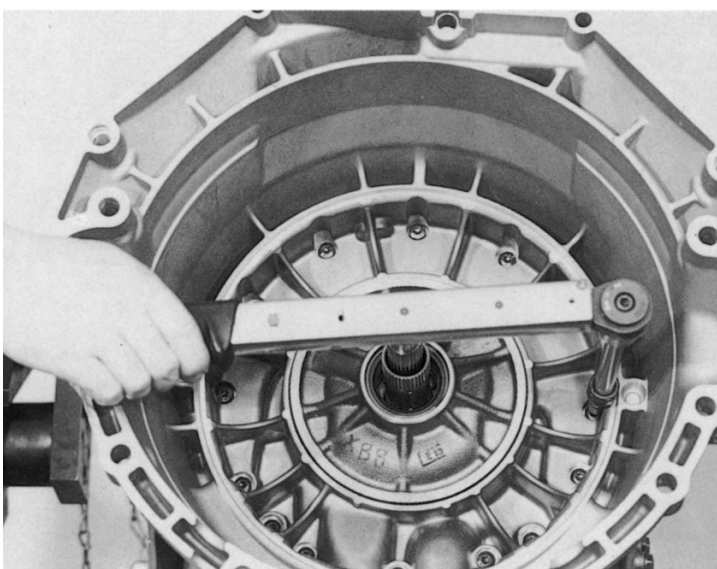

3.7 Shift unit, oil pan and torque converter (complete shift unit, refer to spare list, Technical Data Sheet, Item YO2)

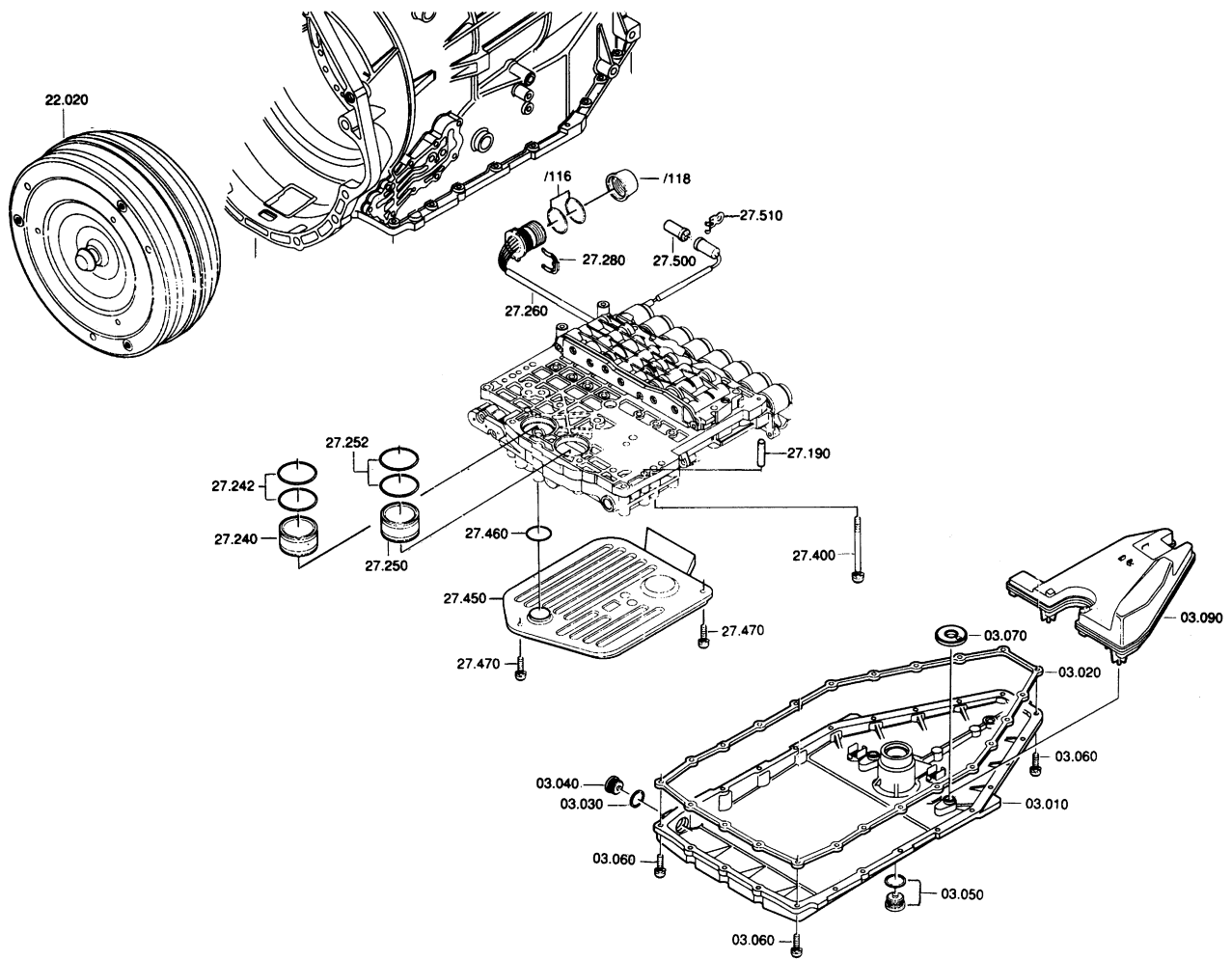

It is recommended practice to check all clutches and brakes for leakage before installing the shift unit: apply jet of compressed air to oil supply to do this.

92 193

Press in dowel pin 27.190. Fit 2 O-rings 27.242 to pipe 27.240 and 2 O-rings 27.252 to pipe 27.250, grease lightly (Vaseline) and press pipes into suction and pressure channel of shift unit respectively.

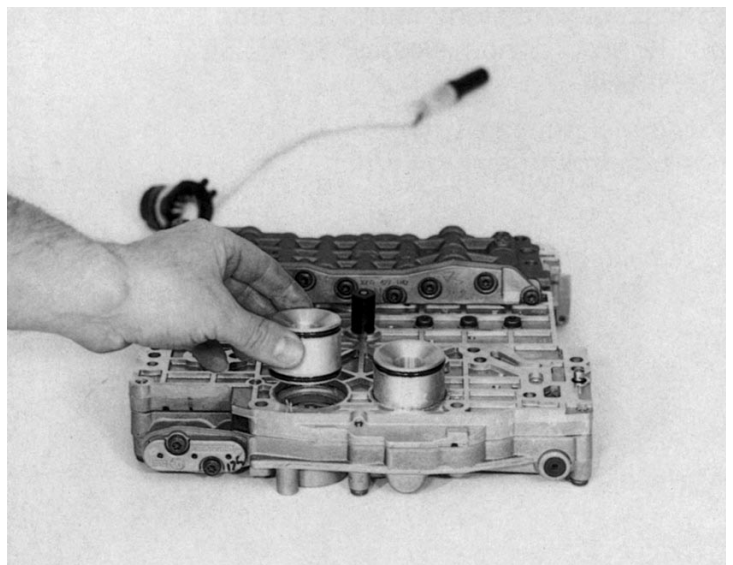

Fit shift unit loosely. Fit 2 new O-rings 27.260/116 on the plug of the cable harness and grease lightly (Vaseline). Align plug in such a way that the 2 lugs on the plug can locate on the lug in the transmission housing.

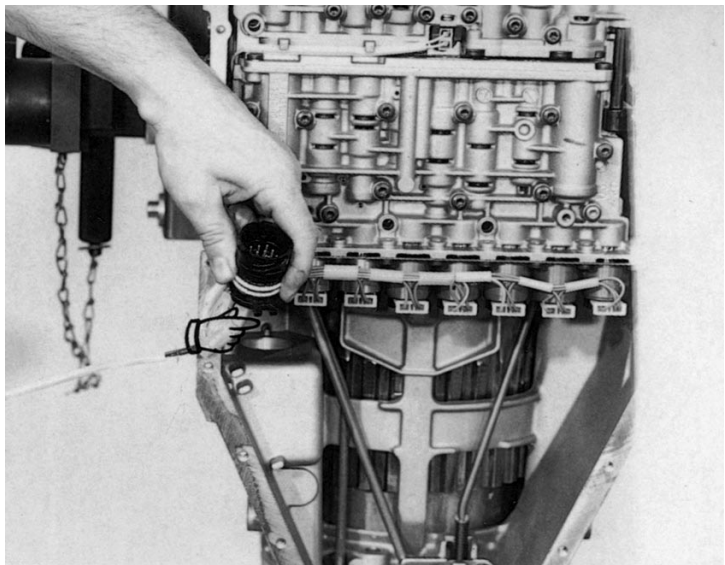

Press in plug and secure using retaining clip 27.280.
Attach dust cover 27.260/118.

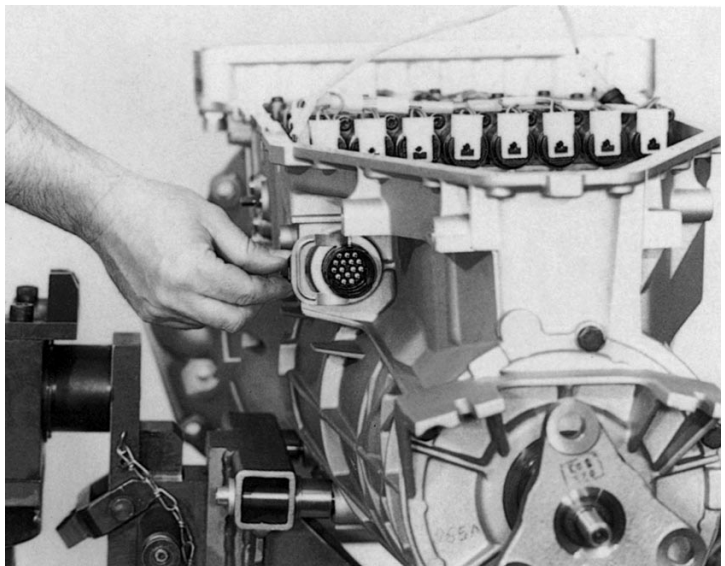

Press on shift unit by hand and secure using 12 machine screws 27.400.

(Wrench size = Torx - TX 27)
(Tightening torque = 8 Nm)

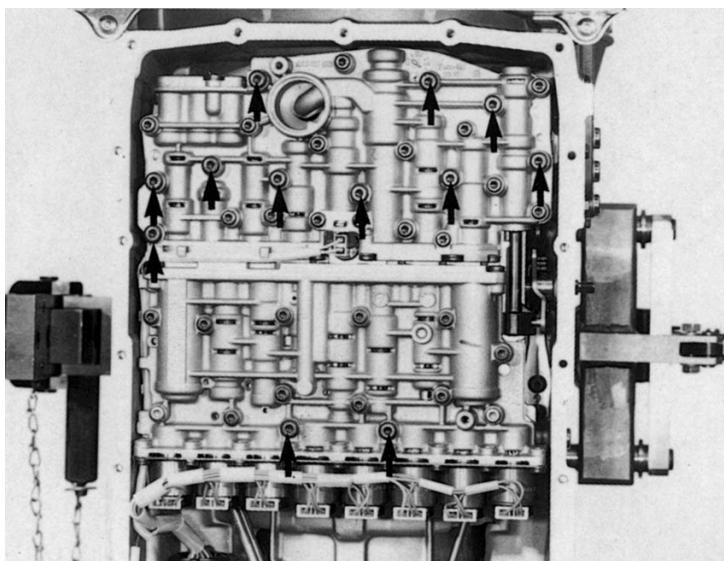

Fit O-ring 27.460 to spigot of filter 27.450.
Secure filter with 2 machine screws 27.470.

(Wrench size = Torx - TX 27)
(Tightening torque = 5 Nm)

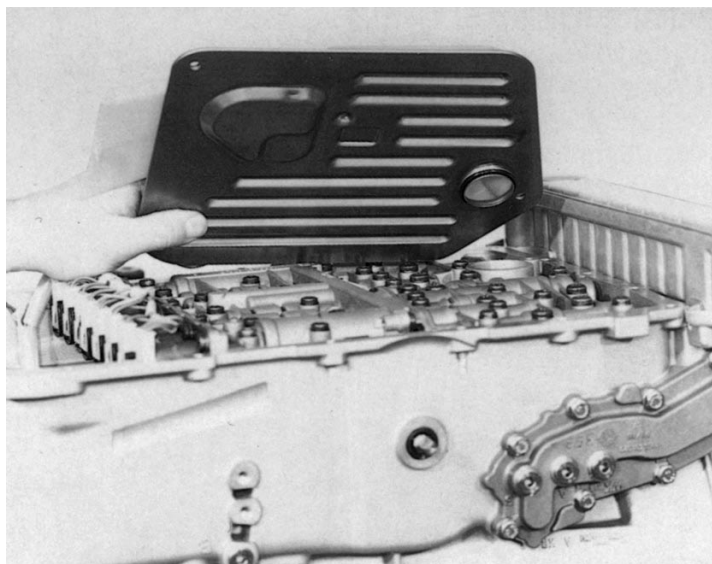

Insert inductive sensor 27.500 in transmission housing and secure using bracket 27.510 and one machine screw 24.080.

(Width across flats = 13 mm)
(Tightening torque = 23 Nm)

Then press cable into appropriate recesses in the transmission housing.

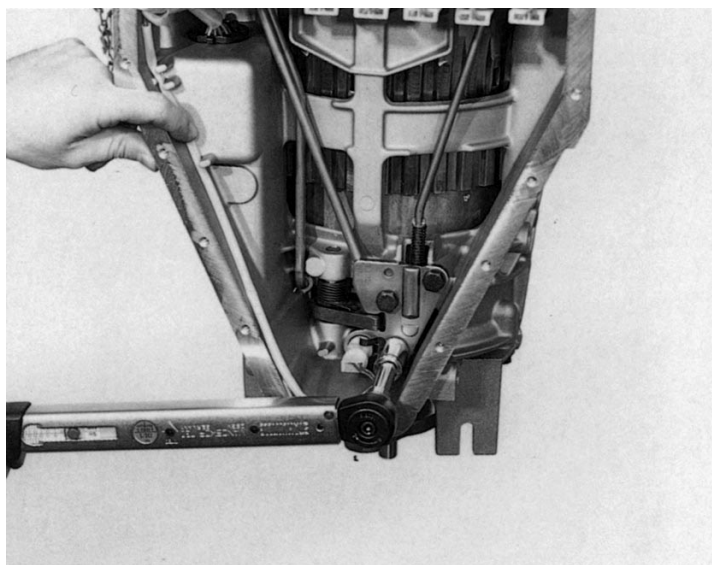

Install oil container 03.090 and fit magnet 03.070 to oil container.



Attach gasket 03.020 to transmission housing with grease (Vaseline) and align.

Fit oil pan 03.010 and tighten down using 23 machine screws 03.060.

(Wrench size = Torx - TX 27)
(Tightening torque = 10 Nm)

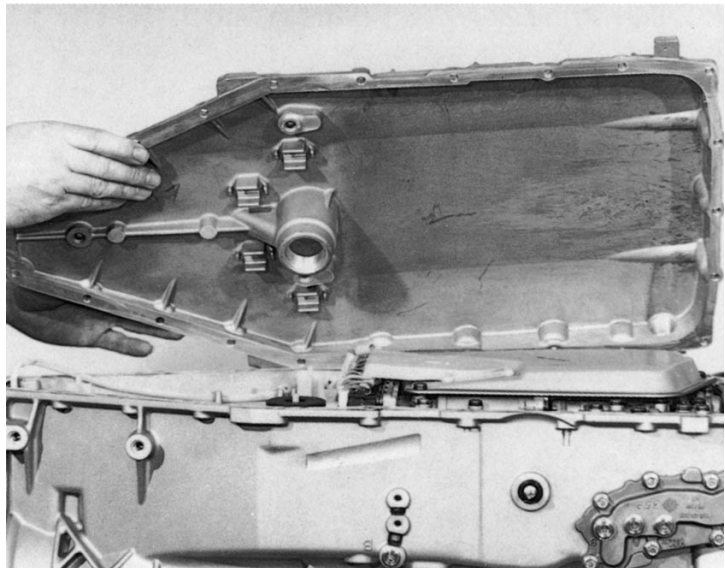

Fit new sealing ring 03.030 to screw plug 03.040 and fasten screw plug 03.050 into oil pan.

(Width across flats - cap screw

Item 03.040 = 14 mm

Item 03.050 = 17 mm)

(Tightening torque =

Item 03.040 = 50 Nm

Item 03.050 = 100 Nm)

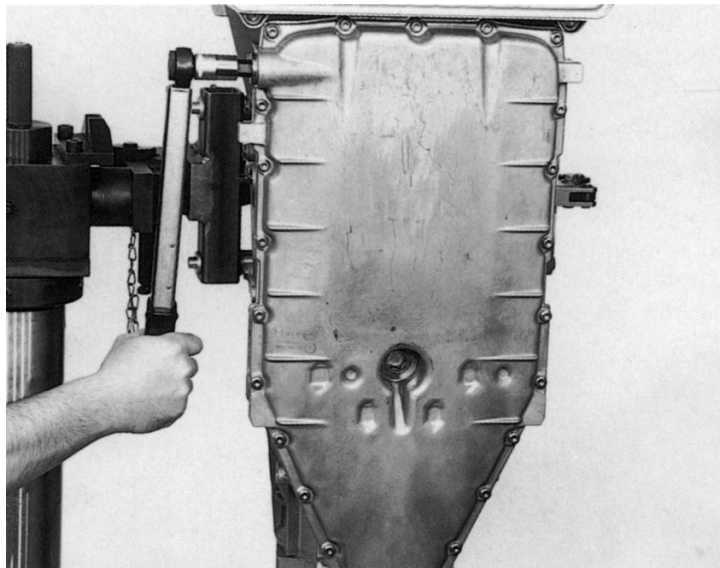

Screw in both torque converter grips 5 X 56 000 090 and carefully install torque converter 22.020.

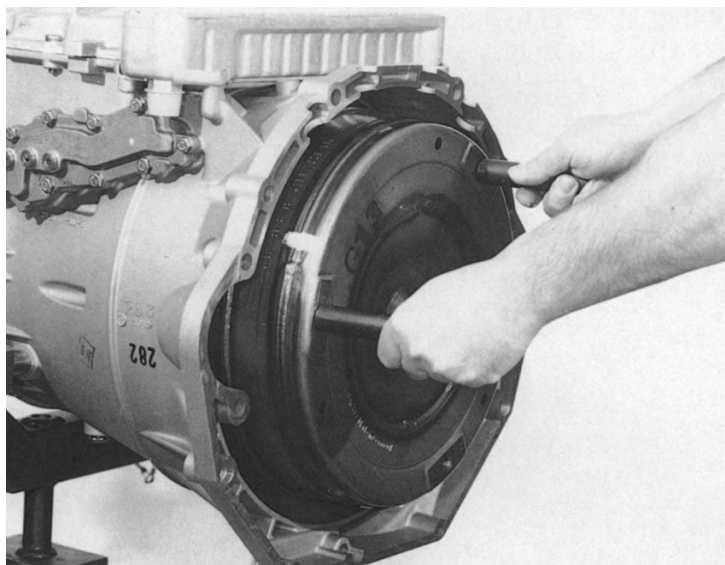

92 202

Rotate transmission through 90 degrees and turn torque converter to and fro until splined pump spigot engages.

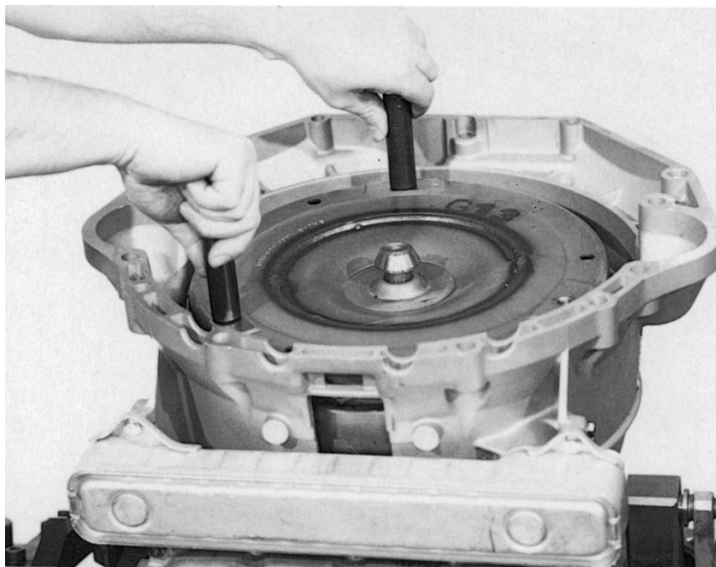

92 203

Screw on torque converter retaining bracket.

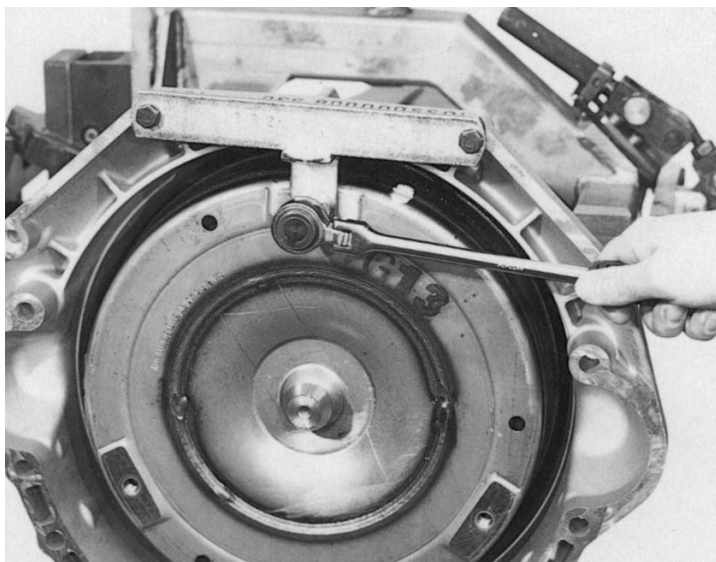

92 204

Fit all transport plugs and caps:

- Item 01.300/010 - 2 protective pipe covers on oil cooler
- Item 06.050 - 2 plugs on each side of selector shaft
- Item 14.040 - 1 protective cap on output flange
- Item 27.260/118 - 1 seal plug on cable harness

